



**ACOUSTIC
INSPIRATION**



TABLE OF CONTENTS

ACOUSTICS AND ENVIRONMENT	5
ECHOBOARD® FOR BETTER ROOM ACOUSTICS	6
ECHOBOARD® 12MM	8
DATA SHEET	8
COLOURS	9
ECHOBOARD® 24MM	10
DATA SHEET	10
COLOURS	11
ACOUSTIC CEILINGS	12
ECHOSAIL®	12
ECHOBAFFLE®	18
ACOUSTIC LIGHTING	22
ECHOLED® EQ4	24
ECHOLED® UMBRA	26
ECHOLED® LINEAR	28
ECHOLED® BAFFLE	30
ACOUSTIC WALLS	32
ECHOFIELD®	32
ECHOBRICK®	36
ECHOMONOC®	40
ACOUSTIC ROOM SEPARATORS	44
ECHOCURTAIN®	44
ECHOTORRENT®	48
ACOUSTIC ROOM DIVIDERS	52
ECHOCAVE® ECO	54
ECHOCAVE® PALING	58
ECHOCAVE® STAND	60
ECHOCAVE® MOVE	62
ECHOCAVE® DESK ONE	64
ECHOCAVE® DESK TWO	66
ECHOCAVE® JOINER	68
ECHOCAVE® DESK ADAPTER	69
DO YOU ALREADY KNOW ABOUT ECHOCOUSTIC®?	70
WWW.ECHOJAZZ.COM	71



SUSTAINABLE

We use up to 70 PET bottles to produce one square meter of ECHOJAZZ acoustic absorbers. We offer a product-stewardship-program, in which our products are shredded and used as filling material for our acoustic columns.



ROBUST & LOW MAINTENANCE

EchoBoard® products are hardly ductile and therefore very shape-resistant and tearproof. The cleaning is carried out by means of a (vacuum cleaner). Strong soiling can be removed with all commercially available carpet cleaners without leaving residues.



ACOUSTIC

The open and highly compressed felt structure is more effective than conventional acoustic composites. Though 40% thinner, the EchoBoard® products achieve comparable absorption rates as conventional high-performance acoustic absorbers.



MOISTURE REGULATING

PET-felt absorbs moisture from the environment and releases it again. This contributes to a improved room climate. Since the fiber hardly absorbs water, no mold infestation can arise.



EMISSION FREE

Measurements have shown that by colouring the PET in the liquid state, ECHOJAZZ® products are practically emission-free. In addition, the material does not emit any dangerous fibers that may be inhaled.



LIGHTFASTNESS

The fibers of the PET composite are dyed in the liquid state. EchoBoard® products achieve the highest requirements for application in commercial projects.



FIRE PROTECTION

EchoBoard® 12mm meets the highest European standard (B-s1, d0) of flame retardant materials. In the event of a fire, the material emits no to slight smoke and doesn't produce flaming droplets.



EASY PROCESSING

EchoBoard® products are cut on the CNC cutting plotter. Adaptation work takes place dust-free on site by using carpet knife. Other means of processing include crown drill, circular- or jig-saw.



HEAT STORAGE

EchoBoard® products store heat from the ambient air and delivers it when the air temperature drops. This contributes to lower energy costs and a stable and comfortable room climate.

ACOUSTICS AND ENVIRONMENT

For ECHOJAZZ, acoustics as well as the environment are a strong inspiration to find innovative and sustainable solutions. The EchoBoard® is made of 100% PET with more than 50% recycled PET bottles and, due to its recyclability, is a direct answer to questions of ecological and economic sustainability that arise in modern architecture, interior design and renovation.

In addition, ECHOJAZZ offers its customers the opportunity to return products at the end of their life cycle as part of a product stewardship programme.

ECHOBORD® FOR BETTER ROOM ACOUSTICS

For sound absorption and for optimal room acoustics you will find elegant acoustic ceilings, acoustic lights, acoustic walls and acoustic room dividers. All products are made of our EchoBoard® material and consist of 100% PET fibres.



ECHOFIELD® ROUND



ECHOLED® LINEAR



ECHOCOVE® DESK TWO



DATA SHEET ECHOBORD® 12MM

EchoBoard® 12mm is a high quality sound absorber with an aw of 0.90 and a NRC of 0.85, which can be used for acoustic ceilings, walls, office desks or room dividers.

DESCRIPTION	EchoBoard® 12mm
DIMENSIONS	2380mm (± 1mm) x 1180mm (± 1mm)
COMPOSITION	100% PET (> 50% recycled PET)
PET BOTTLES* PER PANEEL	140 PET Bottles *The number of PET bottles refers to 500ml PET bottles with a bottle weight of 24g.
WEIGHT	2400g/m ² (± 10%)
MATERIAL THICKNESS	12mm
LIGHTFASTNESS ISO 105-B02-1994	> 7
FIRE TEST EN 13501	B-s1, d0
VOC EMISSIONS ASTM D5116	< 0.5mg/m ² /h
FORMALDEHYDE EMISSIONS ASTM D5116	< 0.1mg/m ² /h
ENVIRONMENTAL CERTIFICATIONS	eco-1 rating within eco-bau & Minergie-Eco requirements 1
SOUND ABSORPTION DIN EN ISO 11654 ASTM C423	aw 0.30 (0mm air gap) aw 0.60 (50mm air gap) aw 0.90 (200mm air gap) NRC = 0.45 (0mm air gap) NRC = 0.70 (50mm air gap) NRC = 0.85 (200mm air gap)
COLOURS	7

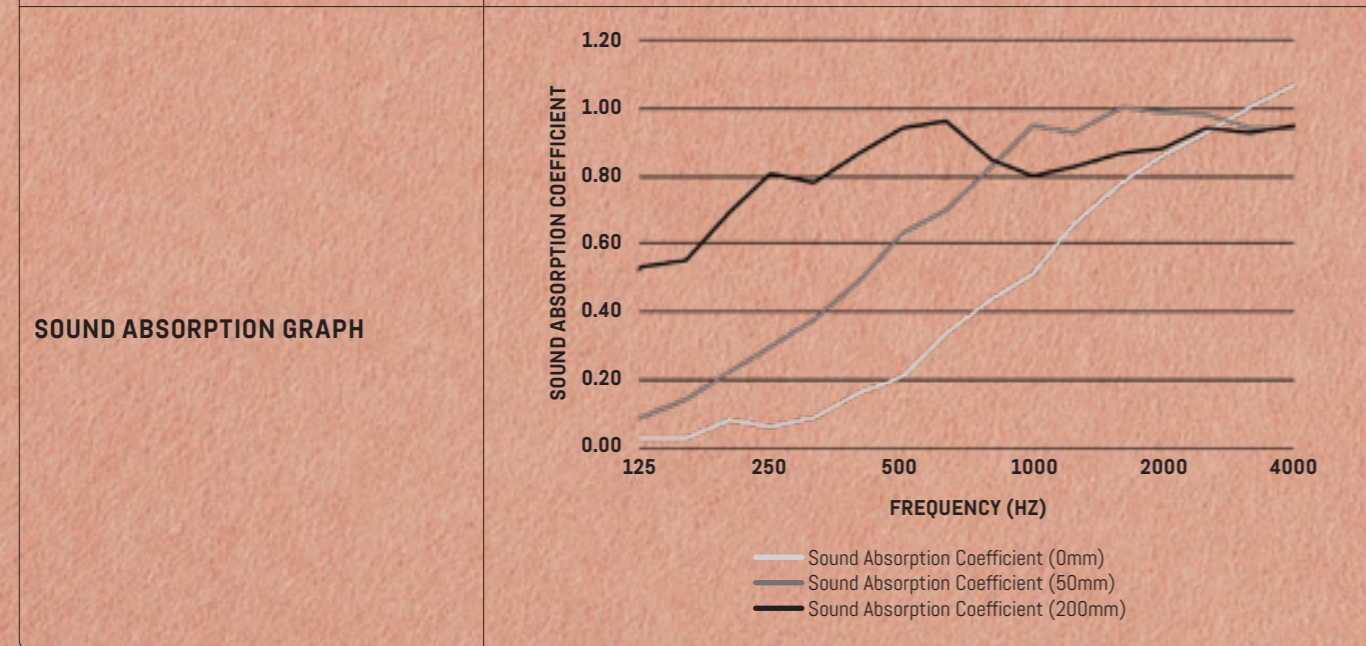

COLOURS ECHOBORD® 12MM

Due to the nature of the material, surface and colour deviations are possible.

ECHOBORD® 12MM CATEGORY I

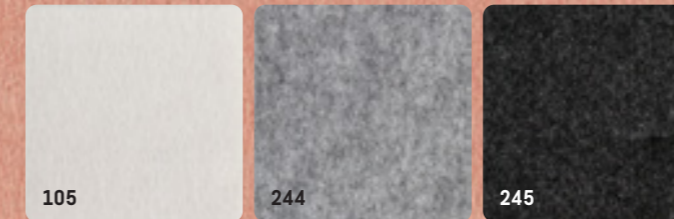

ECHOBORD® 12MM CATEGORY II



DATA SHEET ECHOBOARD® 24MM

EchoBoard® 24mm is a high quality sound absorber with an aw of 1.00 and a NRC of 0.95, which can be used for acoustic ceilings, walls, office desks or room dividers.

DESCRIPTION	EchoBoard® 24mm
DIMENSIONS	2380mm (± 1mm) x 1800mm (± 1mm)
COMPOSITION	100% PET (> 50% recycled PET)
PET BOTTLES* PER PANEEL	303 PET Bottles *The number of PET bottles refers to 500ml PET bottles with a bottle weight of 24g.
WEIGHT	3400g/m ² (± 10%)
MATERIAL THICKNESS	24mm
LIGHTFASTNESS ISO 105-B02-1994	> 7
FIRE PROTECTION EN 13501	B-s2, d0
VOC EMISSIONS ASTM D5116	< 0.5mg/m ² /h
FORMALDEHYDE EMISSIONS ASTM D5116	< 0.1mg/m ² /h
ENVIRONMENTAL CERTIFICATES	eco-1 rating within eco-bau & Minergie-Eco requirements 1
SOUND ABSORPTION EN ISO 11654 ASTM C423	aw 0.50 (0mm air gap) aw 0.65 (50mm air gap) aw 1.00 (200mm air gap) NRC = 0.70 (0mm air gap) NRC = 0.80 (50mm air gap) NRC = 0.95 (200mm air gap)
COLOURS	21

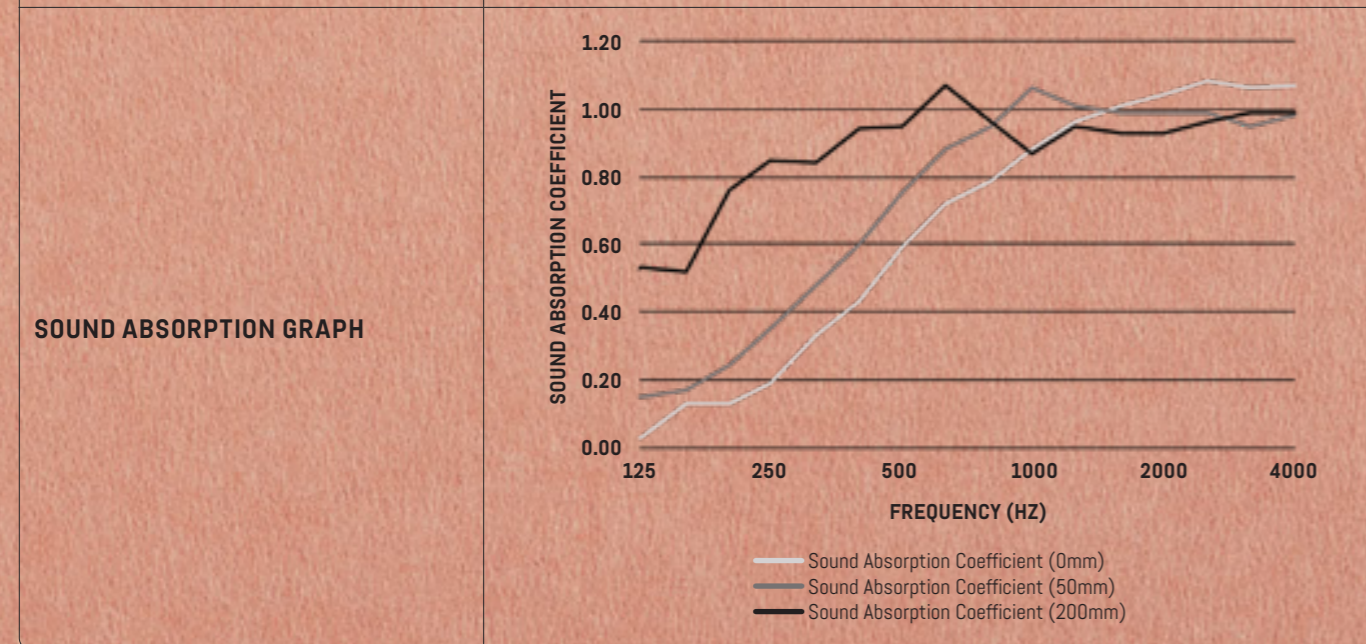

COLOURS ECHOBOARD® 24MM

Due to the nature of the material, surface and colour deviations are possible.

ECHOBOARD® 24MM CATEGORY I



ECHOBOARD® 24MM CATEGORY II





ECHOSAIL® ACOUSTIC CEILINGS

ECHOJAZZ offers an wide range of EchoSail® acoustic sails. However, if you send us the plan specifications of your own design as a vector file, we can cut almost any other shape or perforation to fit your concept. If you need planning support from our specialists, please contact us and we will be happy to advise you!



SUSPENSION FRAME WITH SAFETY HOOKS

ECHOSAIL® 12MM

Acoustic sails in various shapes and surface designs including suspension system up to 1500mm. The EchoSail® is directly screwed and suspended up to a length of 1000mm. For all shapes, which are longer than 1000mm, the EchoSail® is suspended with frame and safety hooks. The frame is white as standard and can be delivered in other colours on request.

Sound absorption: aw 0.90, Class A

Edge processing: 90°, Corner radius 200mm

DESCRIPTION	ARTICLE	W x H x D (in mm)	UNIT	PET BOTTLES
EchoSail® 12mm SQUARE	ESA12SQU118118A	1180 x 1180 x 62	2 Pce	139
EchoSail® 12mm RECTANGLE	ESA12REC238118A	2380 x 1180 x 62	1 Pce	140
EchoSail® 12mm HEXAGON	ESA12HEX118108A	1180 x 1078 x 62	2 Pce	99
EchoSail® 12mm ROUND	ESA12ROU118118A	Ø 1180 x 62	2 Pce	109
EchoSail® 12mm BUTTERFLY	ESA12BUT109081A	1091 x 811 x 49	3 Pce	109

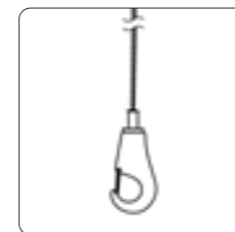

SAFETY HOOK

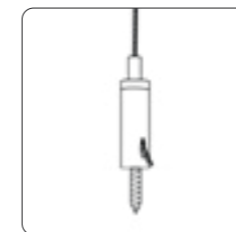

DIRECT SUSPENSION

ECHOSAIL® 12MM SQUARE



ECHOSAIL® 12MM BUTTERFLY



ECHOSAIL® 12MM HEXAGON

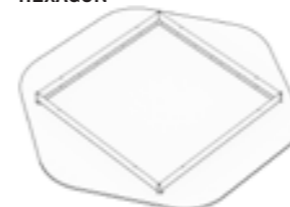

ECHOSAIL® 12MM ROUND

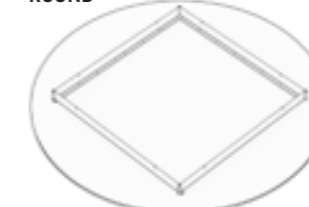

ECHOSAIL® 12MM RECTANGLE

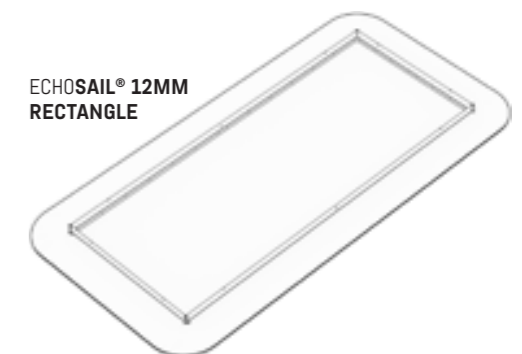

ECHOSAIL® 24MM
SQUARE M



ECHOSAIL® 24MM
SQUARE L

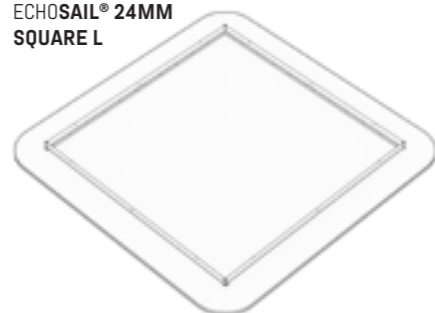

ECHOSAIL® 24MM
RECTANGLE M



ECHOSAIL® 24MM
RECTANGLE L

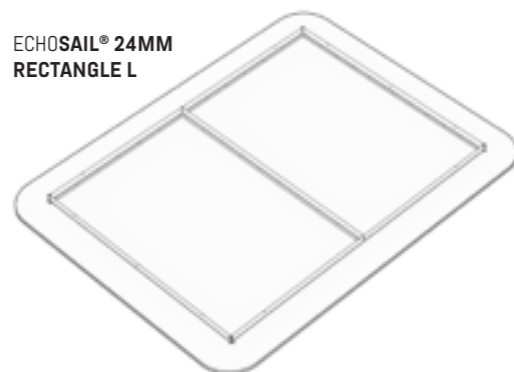

ECHOSAIL® 24MM
HEXAGON M



ECHOSAIL® 24MM
HEXAGON L

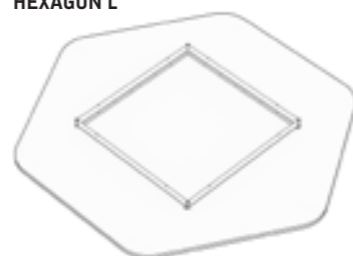

ECHOSAIL® 24MM
ROUND M

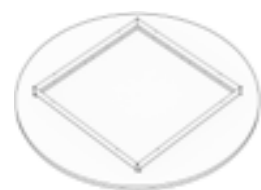

ECHOSAIL® 24MM
ROUND L

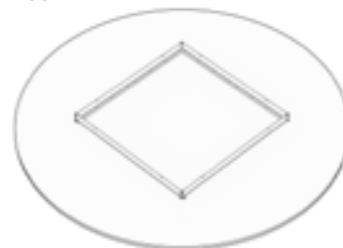

ECHOSAIL® 24MM
BUTTERFLY M



ECHOSAIL® 24MM
BUTTERFLY L

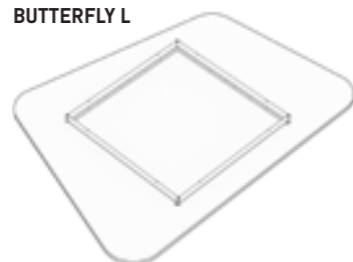

ECHOSAIL® 24MM

Acoustic sails in various shapes and surface designs including suspension system up to 1500mm. The EchoSail® is directly screwed and suspended up to a length of 1000mm. For all shapes, which are longer than 1000mm, the EchoSail® is suspended with frame and safety hooks. The frame is white as standard and can be delivered in other colours on request.

Sound absorption: α_w 1.00, Class A

Edge processing: 90°, Corner radius 200mm

DESCRIPTION	ARTICLE	W x H x D (in mm)	UNIT	PET BOTTLES
EchoSail® 24mm SQUARE M	ESA24SQU118118A	1180 x 1180 x 74	2 Pce	197
EchoSail® 24mm SQUARE L	ESA24SQU180180A	1800 x 1800 x 74	1 Pce	230
EchoSail® 24mm RECTANGLE M	ESA24REC238118A	2380x 1180 x 74	1 Pce	199
EchoSail® 24mm RECTANGLE L	ESA24REC238180A	2380 x 1800 x 74	1 Pce	303
EchoSail® 24mm HEXAGON M	ESA24HEX118108A	1180 x 1078 x 74	2 Pce	141
EchoSail® 24mm HEXAGON L	ESA24HEX180165A	1800 x 1645 x 74	1 Pce	165
EchoSail® 24mm ROUND M	ESA24ROU118118A	Ø 1180 x 61	2 Pce	155
EchoSail® 24mm ROUND L	ESA24ROU180180A	Ø 1800 x 74	1 Pce	180
EchoSail® 24mm BUTTERFLY M	ESA24BUT109081A	1091 x 811 x 74	3 Pce	154
EchoSail® 24mm BUTTERFLY L	ESA24BUT127171A	1273 x 1708 x 74	2 Pce	252
EchoSail® 24mm STONE	ESA24ST0238180A	954-1530 x 820-971 x 61	4 Pce	245
EchoSail® 24mm ROUND RAY M	ESA24ROU118118J	Ø 1180 x 61	2 Pce	115
EchoSail® 24mm ROUND WEB M	ESA24ROU118118D	Ø 1180 x 61	2 Pce	113

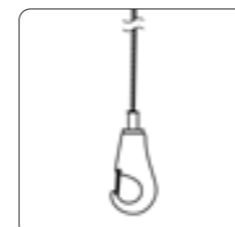

SAFETY HOOK

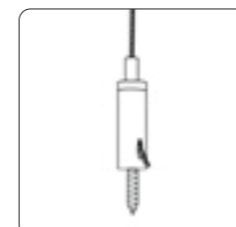

DIRECT SUSPENSION

ECHOSAIL® 24MM
STONE



ECHOSAIL® 24MM
ROUND RAY M



ECHOSAIL® 24MM
ROUND WEB M

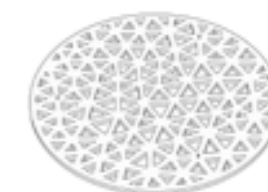



ECHOBaffle® ACOUSTIC CEILINGS

Our acoustic baffles offer an optimal solution for open ceilings, where easy access to building services or the thermoactive air exchange of chilled ceilings must be guaranteed.

Our standard products EchoBaffle® PLAIN, WAVE and EDGE convince by their easy installation by means of a tool-free plug-in system. The mirroring of the segments creates coherent forms which give the room a lot of dynamics. To avoid disturbing joints between the individual baffles, we can connect the elements endlessly and inconspicuously with each other by means of "invisible" puzzle connections. This creates a unitary and closed ceiling pattern without preventing quick access to the ceiling. If the ceiling design is to become a real eye-catcher, we are happy to help you develop a completely individual solution. The ECHOJAZZ team supports you from the initial consultation to the creation of cutting and installation plans: Your inspiration is our challenge!

ECHOBaffle® 12MM

Acoustic baffle design consisting of 10 baffle segments, including substructure and suspension system.

Sound absorption: α_w 0.90, Class A

Individual EchoBaffle® solutions on demand!

DESCRIPTION	ARTICLE	W x H x D (in mm)	UNIT	PET BOTTLES
EchoBaffle® 12mm PLAIN M	EBA12PLA118160A	1180 x 1600 x 235	1 Set	131
EchoBaffle® 12mm PLAIN L	EBA12PLA238160A	2380 x 1600 x 235	1 Set	248
EchoBaffle® 12mm EDGE M	EBA12EDG118160A	1180 x 1600 x 250	1 Set	112
EchoBaffle® 12mm EDGE L	EBA12EDG238160A	2380 x 1600 x 270	1 Set	201
EchoBaffle® 12mm WAVE M	EBA12WAV118160A	1180 x 1600 x 290	1 Set	118
EchoBaffle® 12mm WAVE L	EBA12WAV238160A	2380 x 1600 x 290	1 Set	220

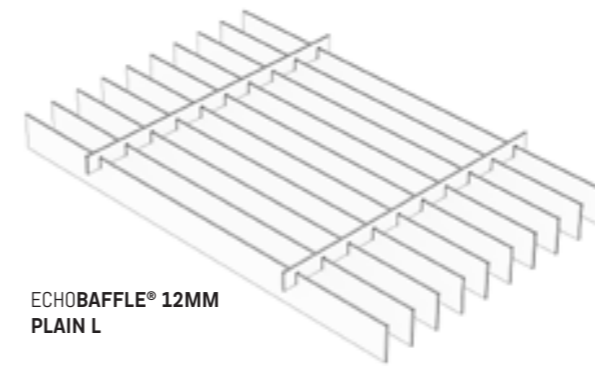

ECHOBaffle® 12MM
PLAIN L

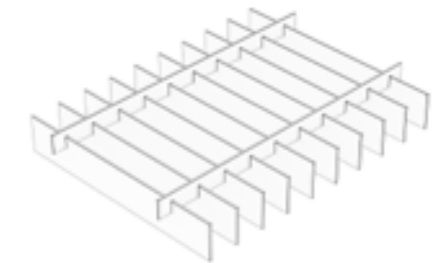

ECHOBaffle® 12MM
PLAIN M

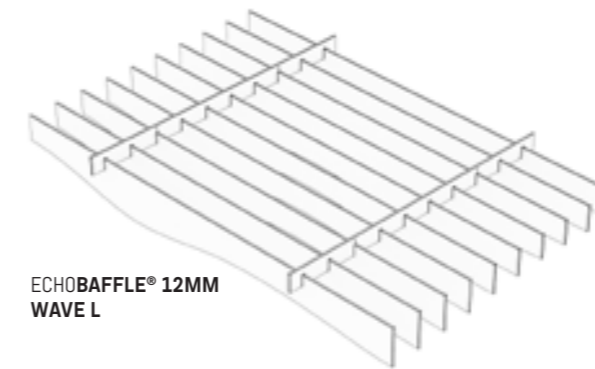

ECHOBaffle® 12MM
WAVE L

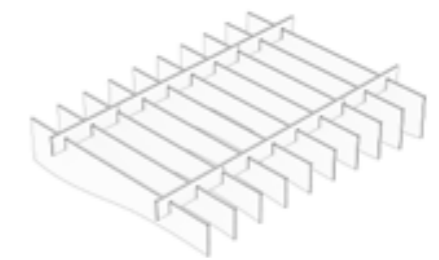

ECHOBaffle® 12MM
WAVE M

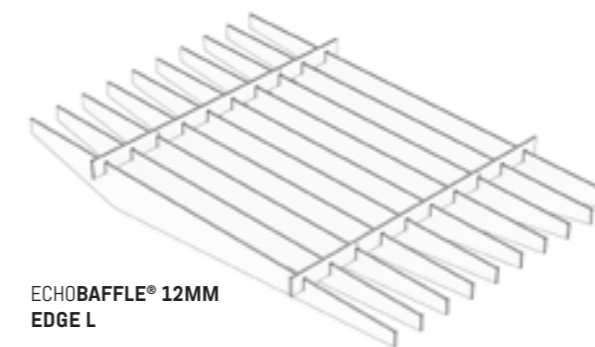

ECHOBaffle® 12MM
EDGE L

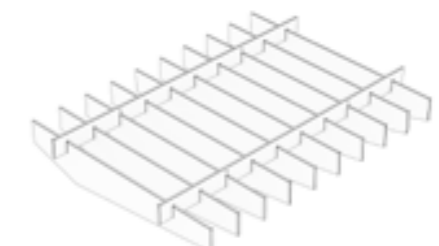

ECHOBaffle® 12MM
EDGE M



ECHOLED® ACOUSTIC LIGHTING

The EchoLED® EQ4 was developed as an elegant and fully integrated workspace light and is manufactured in Switzerland.

EchoLED® EQ4 allows the user to control the light individually by means of a switch on the table or an app. The set-back light exit of 8mm offers a glare-free light, which is hardly visible in the room. The closed four-module can be delivered ready to plug in and can be connected or replaced like a floor lamp. The lamps are integrated flush in the high-performance absorber. Our products are equipped with DALI drivers as standard and offer all the possibilities of digital lighting control.

The EchoLED® LINEAR is integrated flush into the high-performance absorber. The installation of the ceiling sails and the lighting is done in a single operation. All maintenance work on the luminaire can be carried out from below without having to remove the ceiling sail. The modular design of the housing guarantees easy adaptation to future lighting technologies.

The EchoLED® family is characterised by excellent glare reduction values ($UGR < 19$) and very high energy efficiency. It is equipped with DALI drivers as standard and offers all the possibilities of digital lighting control.



ECHOLED® 24MM EQ4
SINGLE M

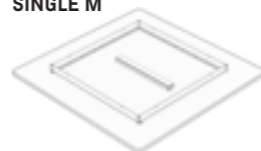

ECHOLED® 24MM EQ4
SINGLE L

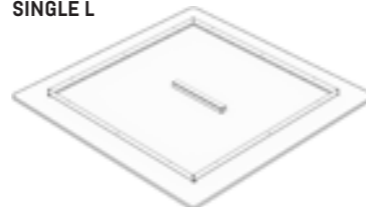

ECHOLED® 24MM EQ4
DOUBLE M

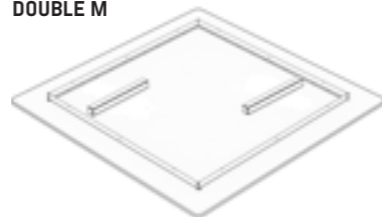

ECHOLED® 24MM EQ4
DOUBLE L

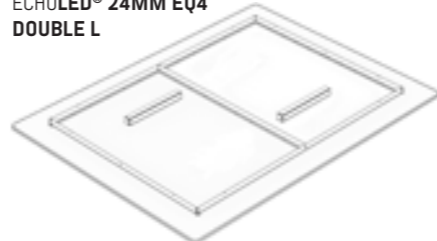

ECHOLED® 24MM EQ4
QUAD L

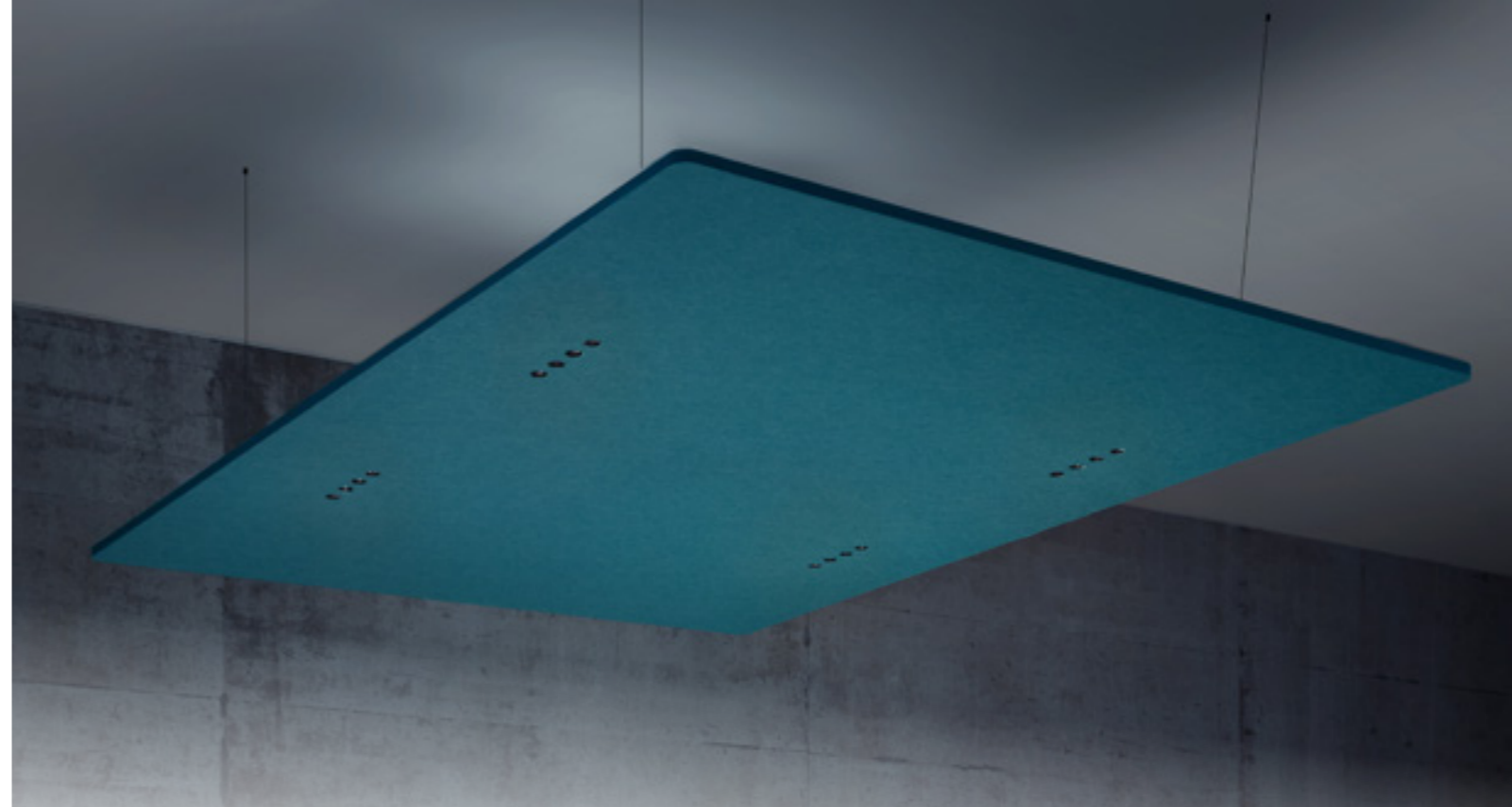
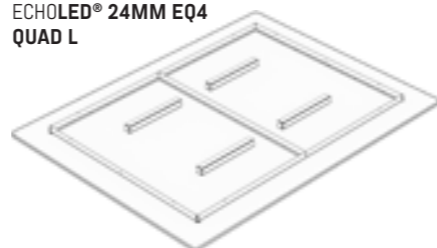

ECHOLED® 24MM EQ4

Acoustic sail with fully integrated lighting with DALI dimming mode including substructure and suspension. The EchoLED® EQ4 luminaire is suspended with frame and safety hooks. The frame is white as standard and can be supplied in other colours on request. Delivery without plug.

Sound absorption: aw 1.00, Class A

Edge processing: 90°, Corner radius 200mm

On request available in ON/OFF and Casambi control

Light colour: 4000K; on request also available with 2700K, 3000K, 3500K

DESCRIPTION	ARTICLE	W x H x D (in mm)	UNIT	PET BOTTLES
EchoLED® 24mm EQ4 SINGLE M	ELE24EQ1118118A	1180 x 1180 x 74	1 Pce	99
EchoLED® 24mm EQ4 SINGLE L	ELE24EQ1180180A	1800 x 1800 x 74	1 Pce	230
EchoLED® 24mm EQ4 DOUBLE M	ELE24EQ2180180A	1800 x 1800 x 74	1 Pce	230
EchoLED® 24mm EQ4 DOUBLE L	ELE24EQ2238180A	2380 x 1800 x 74	1 Pce	303
EchoLED® 24mm EQ4 QUAD L	ELE24EQ4238180A	2380 x 1800 x 74	1 Pce	303

EQ4 LIGHT MODULES

TYPE	DIMENSIONS	LIGHT COLOUR	LUMEN	SYSTEM PERFORMANCE
EQ4	Ø 30mm (4x)	2700K 3000K 3500K 4000K	1320lm	22W

CONNECTION VOLTAGE	220-240V 50/60Hz
PROTECTION CLASS	IP 40 / Schutzclass 1
COLOUR REPRODUCTION	CRI > 90 (4000K)
COLOUR CONSISTENCY	< 3SDMC
ENERGY EFFICIENCY	A++
LIFE SPAN	> 50'000 h (L80 B10)
UGR	< 16

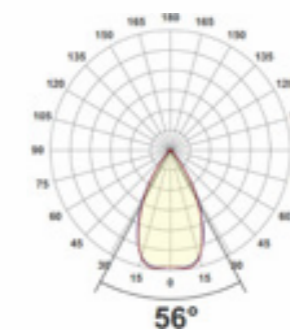



ECHOLED® 12MM UMBRA

Acoustic luminaire with DALI dimming mode including substructure and suspension. Supplied without plug.

Sound absorption: aw 0.90, Class A

On request available in ON/OFF and Casambi control

Light colour: 4000K; on request also available with 2700K, 3000K, 3500K

EchoLED® UMBRA L is available in overlength on request

DESCRIPTION	ARTICLE	W x H x D (in mm)	UNIT	PET BOTTLES
EchoLED® 12mm UMBRA M	ELE12UMB076076A	758 x 758 x 590	1 Pce	94
EchoLED® 12mm UMBRA L	ELE12UMB235105A	2338 x 758 x 590	1 Pce	263

ECHOLED® 12MM
UMBRA M



ECHOLED® 12MM
UMBRA L

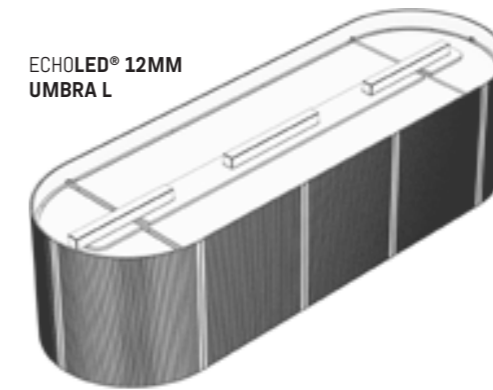

EQ4 LIGHT MODULES

TYPE	DIMENSIONS	LIGHT COLOUR	LUMEN	SYSTEM PERFORMANCE
EQ4	Ø 30mm (4x)	2700K 3000K 3500K 4000K	1320lm	22W

CONNECTION VOLTAGE	220-240V 50/60Hz
PROTECTION CLASS	IP 40 / Schutzclass 1
COLOUR REPRODUCTION	CRI > 90 (4000K)
COLOUR CONSISTENCY	< 3SDMC
ENERGY EFFICIENCY	A++
LIFE SPAN	> 50'000 h (L80 B10)
UGR	< 16

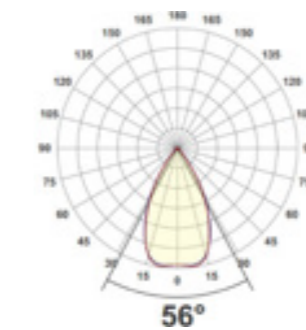



ECHOLED® 24MM LINEAR

Acoustic sail with fully integrated lighting with DALI dimming mode including substructure and suspension. Delivery without plug. The EchoLED® LINEAR luminaire is suspended with frame and safety hooks. The frame is white as standard and can be supplied in other colours on request.

Sound absorption: aW 1.00, Class A
 Edge processing: 90°, Corner radius 200mm
 On request available in ON/OFF and Casambi control
 Light colour: 4000K; on request also available with 3000K

DESCRIPTION	ARTICLE	W x H x D (in mm)	UNIT	PET BOTTLES
EchoLED® 24mm LINEAR M1 SQUARE	ELE24LM1180180A	1800 x 1800 x 74	1 Pce	230
EchoLED® 24mm LINEAR M1 RECTANGLE	ELE24LM1238180A	2380 x 1800 x 74	1 Pce	303
EchoLED® 24mm LINEAR M2 RECTANGLE	ELE24LM2238180A	2380 x 1800 x 74	1 Pce	303
EchoLED® 24mm LINEAR L1 RECTANGLE M	ELE24LL1238118A	2380 x 1180 x 74	1 Pce	199
EchoLED® 24mm LINEAR L1 RECTANGLE L	ELE24LL1238180A	2380 x 1800 x 74	1 Pce	303

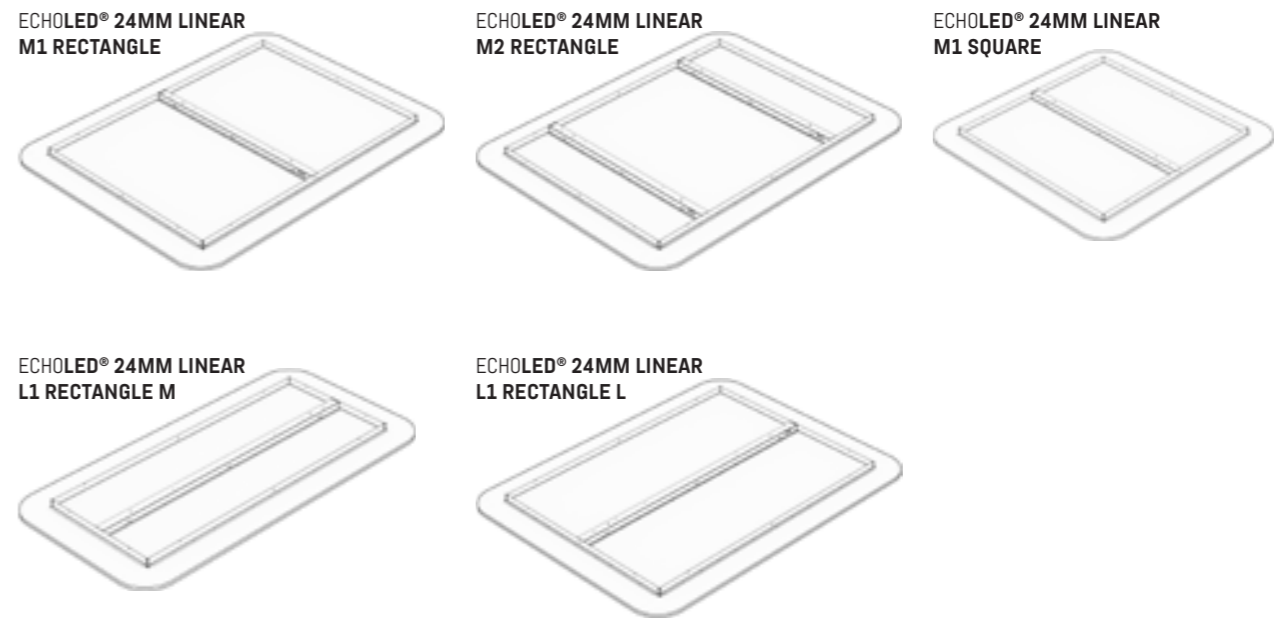

ECHOLED® LIGHT MODULES

TYPE	DIMENSIONS	LIGHT COLOUR	LUMEN	SYSTEM PERFORMANCE
M	1420mm x 60mm	3000K 4000K	4700lm	37W
L	1980mm x 60mm	3000K 4000K	6100lm	48W

- CONNECTION VOLTAGE** 230 V +/- 10% AC/DC
- PROTECTION CLASS** IP 20 / Schutzclass 1
- COLOUR REPRODUCTION** CRI > 80
- COLOUR CONSISTENCY** < 3SDMC
- ENERGY EFFICIENCY** A++
- LIFE SPAN** > 50'000 h (L80 B10)
- DIFFUSOR** Microprism
- UGR** < 19

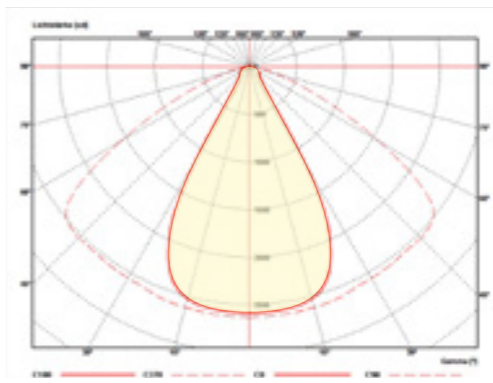



ECHOLED® 12MM BAFFLE®

Acoustic sail with fully integrated lighting with DALI dimming mode including substructure and suspension. Delivery without plug.

Sound absorption: aW 0.90, Class A

Edge processing: 90°

On request available in ON/OFF and Casambi control

Light colour: 4000K; on request also available with 3000K

DESCRIPTION	ARTICLE	W x H x D (in mm)	UNIT	PET BOTTLES
EchoLED® 12mm Baffle® M	ELE12BAF151029A	1510 x 290 x 85	1 Pce	45
EchoLED® 12mm Baffle® L	ELE12BAF209029A	2090 x 290 x 85	1 Pce	62

ECHOLED® 12MM
BAFFLE® M

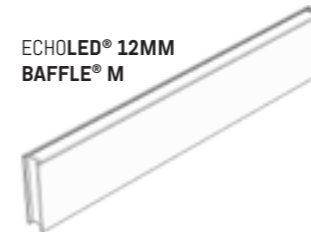

ECHOLED® 12MM
BAFFLE® L

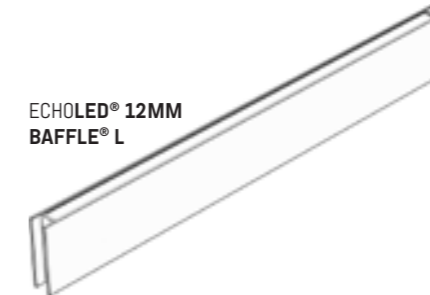

ECHOLED® LIGHT MODULES

TYPE	DIMENSIONS	LIGHT COLOUR	LUMEN	SYSTEM PERFORMANCE
M	1420mm x 60mm	3000K 4000K	4700lm	37W
L	1980mm x 60mm	3000K 4000K	6100lm	48W

CONNECTION VOLTAGE	230 V +/- 10% AC/DC
PROTECTION CLASS	IP 20 / Schutzclass 1
COLOUR REPRODUCTION	CRI > 80
COLOUR CONSISTENCY	< 3SDMC
ENERGY EFFICIENCY	A++
LIFE SPAN	> 50'000 h (L80 B10)
DIFFUSOR	Microprism
UGR	< 19

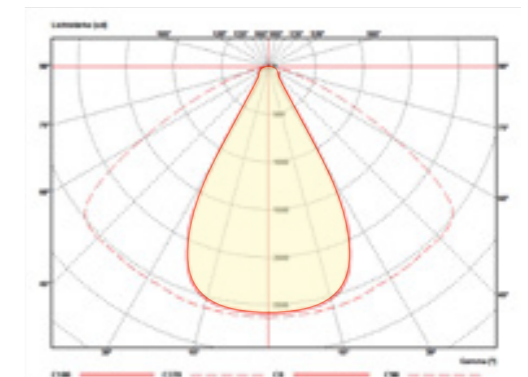

ECHOFIELD® ACOUSTIC WALLS

The EchoField® product range is a wall absorber with a wall spacer and is available in 4 shapes. The powder-coated metal frame can be simply plugged in and suspended by means of a wall profile. The cavity and the lateral terminations ensure optimum acoustic performance. Wall absorbers can offer an effective alternative to acoustic ceilings, especially in small and narrow rooms. ECHOJAZZ acoustic absorbers are extremely robust and can be cleaned easily. They are therefore particularly suitable when they are touched or bumped against in daily use.



ECHOFIELD® 12MM

Acoustic fields in various shapes and surface designs including wall mounting.
 Sound absorption: α_w 0.90, Class A
 Edge processing: 90°, Corner radius 200mm

DESCRIPTION	ARTICLE	W x H x D (in mm)	UNIT	PET BOTTLES
EchoField® 12mm SQUARE M	EFI12SQU118118A	1180 x 1180 x 62	2 Pce	139
EchoField® 12mm RECTANGLE M	EFI12REC238118A	2380 x 1180 x 62	1 Pce	140
EchoField® 12mm HEXAGON M	EFI12HEX118108A	1180 x 1078 x 62	2 Pce	99
EchoField® 12mm ROUND M	EFI12ROU118118A	∅ 1180 x 62	2 Pce	109

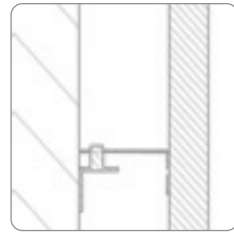

WALL SUSPENSION

ECHOFIELD® 12MM
RECTANGLE



ECHOFIELD® 12MM
SQUARE



ECHOFIELD® 12MM
HEXAGON



ECHOFIELD® 12MM
ROUND

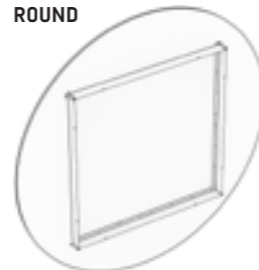

ECHOFIELD® 24MM

Acoustic fields in various shapes and surface designs including wall mounting.
 Sound absorption: α_w 1.00, Class A
 Edge processing: 90°, Corner radius 200mm

DESCRIPTION	ARTICLE	W x H x D (in mm)	UNIT	PET BOTTLES
EchoField® 24mm SQUARE M	EFI24SQU118118A	1180 x 1180 x 74	2 Pce	197
EchoField® 24mm SQUARE L	EFI24SQU180180A	1800 x 1800 x 74	1 Pce	230
EchoField® 24mm RECTANGLE M	EFI24REC238118A	2380 x 1180 x 74	1 Pce	199
EchoField® 24mm RECTANGLE L	EFI24REC238180A	2380 x 1800 x 74	1 Pce	303
EchoField® 24mm HEXAGON M	EFI24HEX118108A	1180 x 1078 x 74	2 Pce	141
EchoField® 24mm HEXAGON L	EFI24HEX180165A	1800 x 1645 x 74	1 Pce	165
EchoField® 24mm ROUND M	EFI24ROU118118A	∅ 1180 x 74	2 Pce	155
EchoField® 24mm ROUND L	EFI24ROU180180A	∅ 1800 x 74	1 Pce	180

ECHOFIELD® 24MM
SQUARE M



ECHOFIELD® 24MM
ROUND M

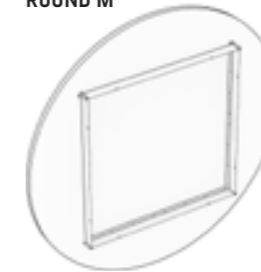

ECHOFIELD® 24MM
HEXAGON M



ECHOFIELD® 24MM
ROUND L

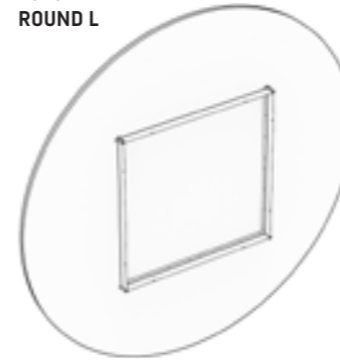

ECHOFIELD® 24MM
HEXAGON L

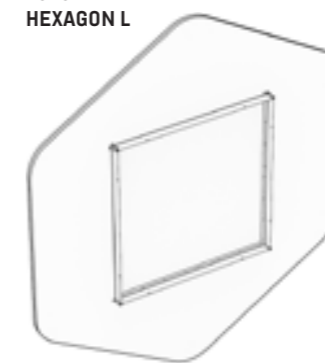

ECHOFIELD® 24MM
SQUARE L



ECHOFIELD® 24MM
RECTANGLE L



ECHOFIELD® 24MM
RECTANGLE M



ECHOBRICK® ACOUSTIC WALLS

EchoBrick® is an acoustic absorber that was primarily developed for use in wall areas. Wall absorbers can be an effective addition or alternative to acoustic ceilings, especially in small and narrow rooms.

In order to improve the acoustic effect, the 12mm material in particular should be mounted on the wall at a distance of 50mm. The 24mm material achieves an α_w value of 0.50 even with a direct installation.

EchoBrick® offers a standard range of 16 products, shapes and material thicknesses which can be combined with each other. The edges of each Brick® are finished with a 6mm deep 45° bevel. This creates intentional shadow lines at the edges of the bricks. The installation is done with EchoGlue®, our biodegradable spray contact adhesive. Adjustments are made quickly and dust-free.



ECHOBRICK® 12MM

Acoustic wall tiles with chamfer. Installation using biodegradable EchoGlue® spray adhesive (included)
 Sound absorption: aw 0.30/0.60 (0mm/50mm air gap)
 Special dimensions and designs on request

DESCRIPTION	ARTICLE	W x H x D (in mm)	UNIT	PET BOTTLES
EchoBrick® 12mm PLANK ONE S	EBR12PLK015118A	145 x 1180 x 12	16 Pce	137
EchoBrick® 12mm PLANK ONE M	EBR12PLK030118A	295 x 1180 x 12	8 Pce	139
EchoBrick® 12mm PLANK ONE L	EBR12PLK059118A	590 x 1180 x 12	4 Pce	139
EchoBrick® 12mm PLANK TWO S	EBR12PLK015238A	145 x 2380 x 12	8 Pce	138
EchoBrick® 12mm PLANK TWO M	EBR12PLK030238A	295 x 2380 x 12	4 Pce	140
EchoBrick® 12mm PLANK TWO L	EBR12PLK059238A	590 x 2380 x 12	2 Pce	140
EchoBrick® 12mm HEXAGON M	EBR12HEX030026A	295 x 255 x 12	41 Pce	116
EchoBrick® 12mm HEXAGON L	EBR12HEX059051A	590 x 511 x 12	8 Pce	90

ECHOBRICK® 12MM
PLANK ONE S



ECHOBRICK® 12MM
PLANK ONE M



ECHOBRICK® 12MM
PLANK ONE L



ECHOBRICK® 12MM
HEXAGON M



ECHOBRICK® 12MM
PLANK TWO S

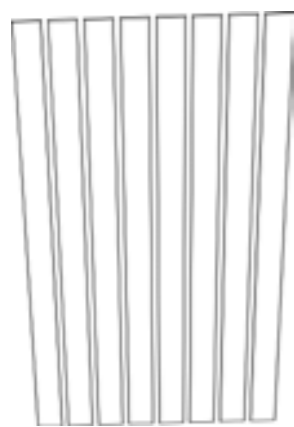

ECHOBRICK® 12MM
PLANK TWO M

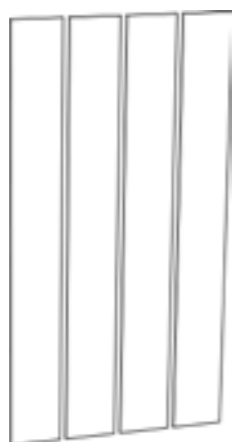

ECHOBRICK® 12MM
PLANK TWO L



ECHOBRICK® 12MM
HEXAGON L

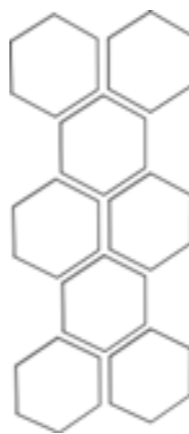

ECHOBRICK® 24MM

Acoustic wall tiles with chamfer. Installation using biodegradable EchoGlue® spray adhesive (included)
 Sound absorption: aw 0.50/0.65 (0mm/50mm air gap)
 Special dimensions and designs on request

DESCRIPTION	ARTICLE	W x H x D (in mm)	UNIT	PET BOTTLES
EchoBrick® 24mm PLANK ONE S	EBR24PLK015118A	145 x 1180 x 24	24 Pce	291
EchoBrick® 24mm PLANK ONE M	EBR24PLK030118A	295 x 1180 x 24	12 Pce	296
EchoBrick® 24mm PLANK ONE L	EBR24PLK059118A	590 x 1180 x 24	6 Pce	296
EchoBrick® 24mm PLANK TWO S	EBR24PLK015238A	145 x 2380 x 24	12 Pce	293
EchoBrick® 24mm PLANK TWO M	EBR24PLK030238A	295 x 2380 x 24	6 Pce	298
EchoBrick® 24mm PLANK TWO L	EBR24PLK059238A	590 x 2380 x 24	3 Pce	298
EchoBrick® 24mm HEXAGON M	EBR24HEX030026A	295 x 255 x 24	65 Pce	260
EchoBrick® 24mm HEXAGON L	EBR24HEX059051A	590 x 511 x 24	15 Pce	240

ECHOBRICK® 24MM
PLANK ONE S



ECHOBRICK® 24MM
PLANK ONE M



ECHOBRICK® 24MM
PLANK ONE L



ECHOBRICK® 24MM
HEXAGON M

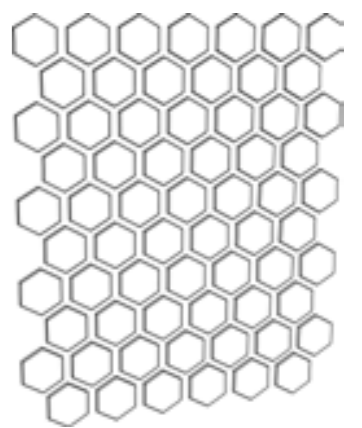

ECHOBRICK® 24MM
PLANK TWO S



ECHOBRICK® 24MM
PLANK TWO M

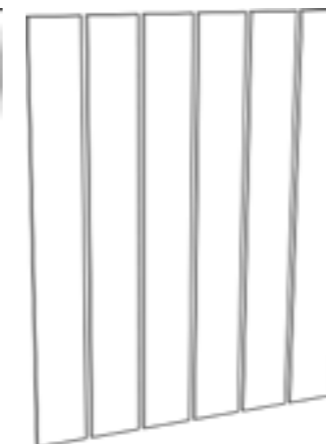

ECHOBRICK® 24MM
PLANK TWO L



ECHOBRICK® 24MM
HEXAGON L

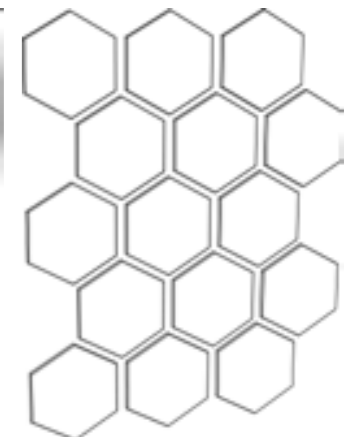



ECHOMONOC® ACOUSTIC WALLS

EchoMonoc® is the logical further development of our EchoBrick® collection and is available in 12mm and 24mm material thickness. The product is manufactured in large format to create monochrome surfaces.

The wall absorbers can offer an effective alternative to acoustic ceilings, especially in small and narrow rooms. ECHOJAZZ acoustic absorbers are extremely robust and can be cleaned easily, especially when touched or bumped against in daily use. The 24mm material achieves an α_w value of 0.50 even with a direct installation. To further improve the acoustic effect, the elements can be mounted on the wall at a distance of 50mm. The edges of each EchoMonocs® are finished with a 45° bevel. (Exception: EchoMonoc® VERTIGO with a 30° bevel) The installation is done with EchoGlue®, our biodegradable spray contact adhesive. The elements can be individually cut to size at the construction site.

ECHOMONOC® 12MM

Acoustic wall panels with chamfer. Installation using biodegradable EchoGlue® spray adhesive (included)
 Sound absorption: aw 0.30/0.60 (0mm/50mm air gap)
 Special dimensions and designs on request

DESCRIPTION	ARTICLE	W x H x D (in mm)	UNIT	PET BOTTLES
EchoMonoc® 12mm FISHBONE	EM012FIS238118A	1180 x 2360 x 12	1 Pce	139
EchoMonoc® 12mm FLOW	EM012FLO238118A	1180 x 2360 x 12	1 Pce	139
EchoMonoc® 12mm KINGSCROSS	EM012KIN238118A	1180 x 2360 x 12	1 Pce	139
EchoMonoc® 12mm VERTIGO	EM012VER238118A	1170 x 2380 x 12	1 Pce	139

ECHOMONOC® 12MM
FISHBONE

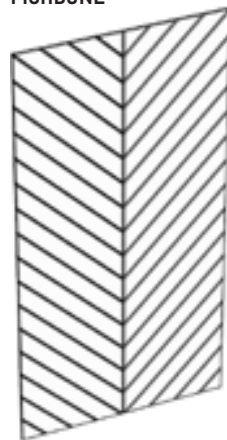

ECHOMONOC® 12MM
FLOW



ECHOMONOC® 12MM
KINGSCROSS



ECHOMONOC® 12MM
VERTIGO



ECHOMONOC® 24MM

Acoustic wall panels with chamfer. Installation using biodegradable EchoGlue® spray adhesive (included)
 Sound absorption: aw 0.50/0.65 (0mm/50mm air gap)
 Special dimensions and designs on request

DESCRIPTION	ARTICLE	W x H x D (in mm)	UNIT	PET BOTTLES
EchoMonoc® 24mm FISHBONE	EM024FIS238180A	1170 x 2360 x 24	1 Pce	296
EchoMonoc® 24mm FLOW	EM024FLO238180A	1170 x 2360 x 24	1 Pce	296
EchoMonoc® 24mm KINGSCROSS	EM024KIN238180A	1170 x 2360 x 24	1 Pce	296
EchoMonoc® 24mm VERTIGO	EM024VER238180A	1800 x 2380 x 24	1 Pce	303

ECHOMONOC® 24MM
FISHBONE

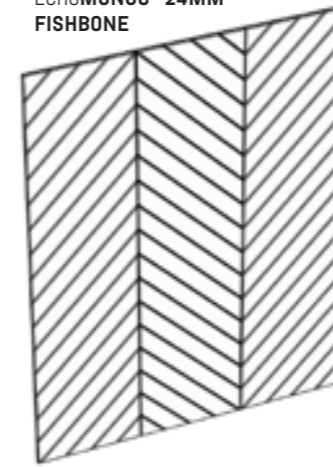

ECHOMONOC® 24MM
FLOW



ECHOMONOC® 24MM
KINGSCROSS

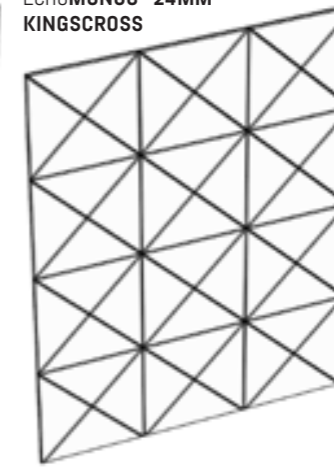

ECHOMONOC® 24MM
VERTIGO





ECHOCURTAIN® ACOUSTIC ROOM SEPARATOR

As an acoustic room divider in the open-space office, the EchoCurtain® offers a flexible and transparent solution in the two material thicknesses 12mm and 24mm, with a perforation of maximum 20%. The EchoCurtain® is suspended directly from the ceiling using steel cable suspension. On request we can offer EchoCurtain® with a rail system. In addition to our standard designs, we are also happy to produce individual solutions. Our design team will support you in design and data creation.

ECHOCURTAIN® 12MM

Hanging acoustic screens incl. suspension system
 Sound absorption: aw 0.90, Class A
 Special dimensions and designs on request

DESCRIPTION	ARTICLE	W x H x D (in mm)	UNIT	PET BOTTLES
EchoCurtain® 12mm PLAIN	ECU12ECU118238A	1180 x 2380 x 12	1 Pce	140

ECHOCURTAIN® 12MM
PLAIN



ECHOCURTAIN® 12MM
FOREST

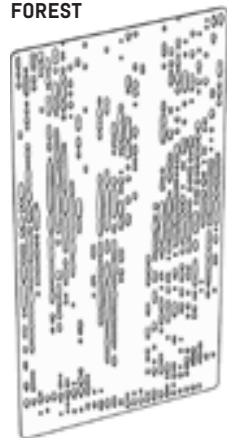

ECHOCURTAIN® 12MM
BUBBLES

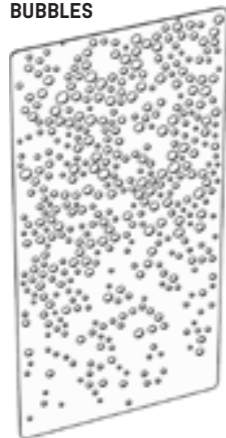

ECHOCURTAIN® 12MM
PUNCH

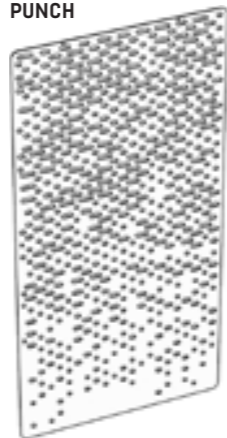

ECHOCURTAIN® 12MM
WEB

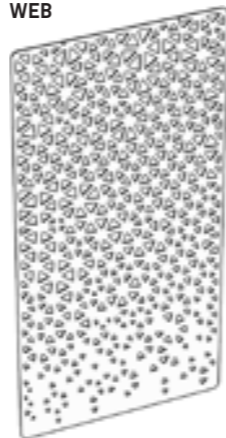

ECHOCURTAIN® 12MM
GRID A

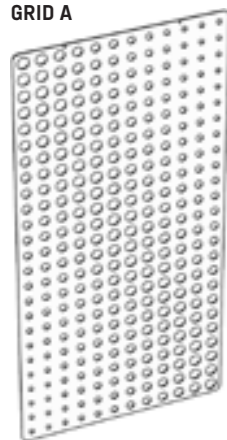

ECHOCURTAIN® 12MM
GRID B

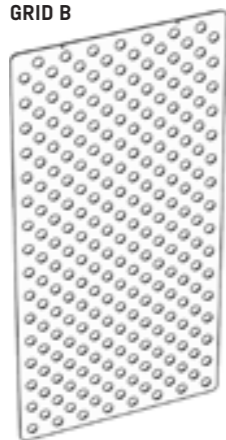

ECHOCURTAIN® 12MM
GRID C

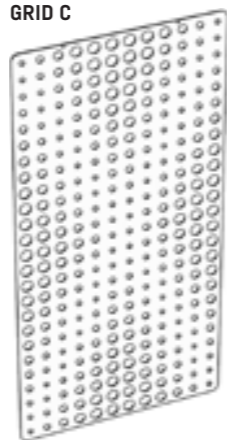

ECHOCURTAIN® 12MM
GRID D

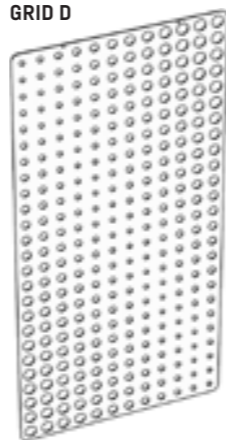

ECHOCURTAIN® 24MM

Hanging acoustic screens incl. suspension system
 Sound absorption: aw 1.00, Class A
 Special dimensions and designs on request

DESCRIPTION	ARTICLE	W x H x D (in mm)	UNIT	PET BOTTLES
EchoCurtain® 24mm PLAIN	ECU24ECU180238A	1800 x 2380 x 24	1 Pce	303

ECHOCURTAIN® 24MM
PLAIN®

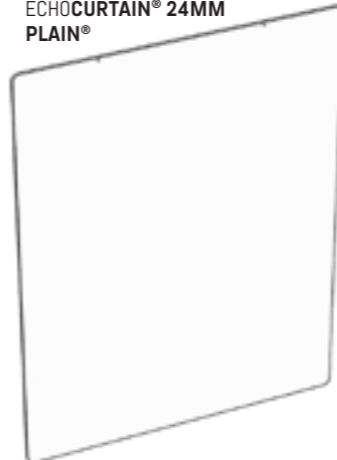

ECHOCURTAIN® 24MM
FOREST

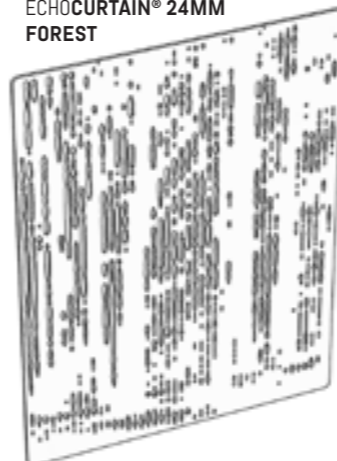

ECHOCURTAIN® 24MM
BUBBLES

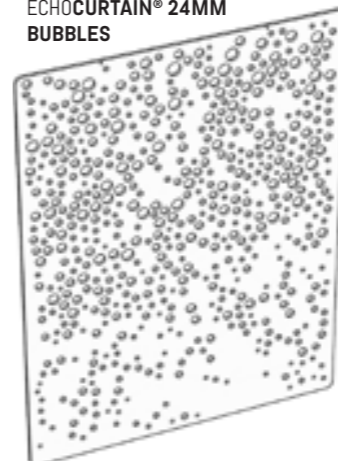

ECHOCURTAIN® 24MM
PUNCH

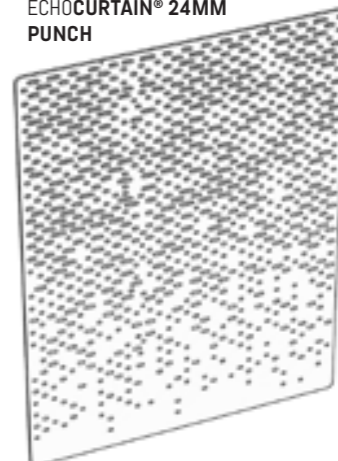

ECHOCURTAIN® 24MM
WEB

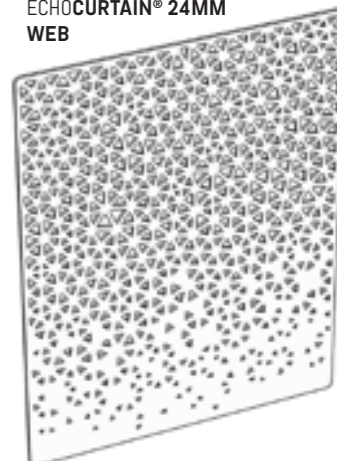

ECHOCURTAIN® 24MM
GRID A

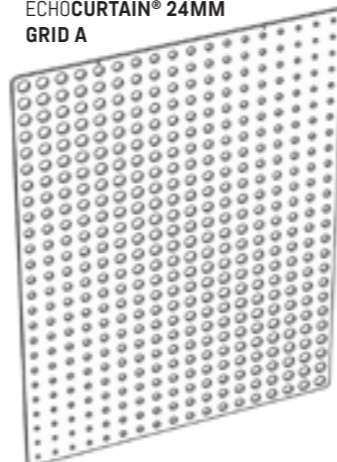

ECHOCURTAIN® 24MM
GRID B

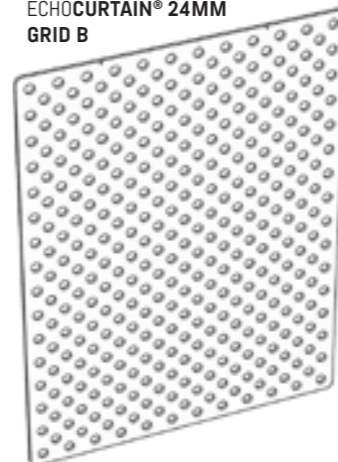

ECHOCURTAIN® 24MM
GRID C

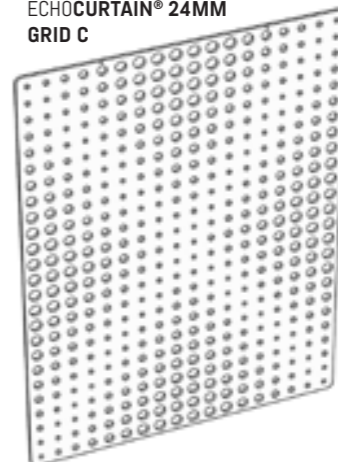

ECHOCURTAIN® 24MM
GRID D

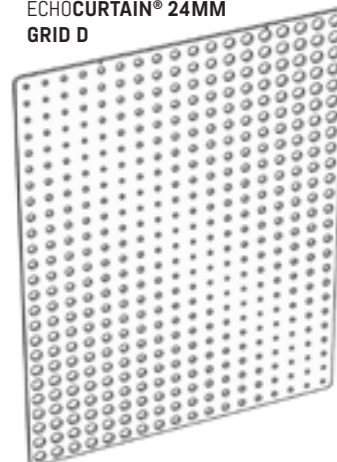



ECHOTORRENT® ACOUSTIC ROOM SEPARATOR

EchoTorrent® is a flexible room dividing element which can be used up to 4m room height. The clamping elements are screwed tightly to the ceiling and floor. The acoustic elements are clamped to the connecting cables and can be individually adjusted in height. The elements are available in 12mm and 24mm material thickness, in two sizes and 21 colours.



ECHOTORRENT® 12MM

Three hanging acoustic elements per set including suspension system
 Sound absorption: aw 0.90, Class A
Special dimensions and designs on request

DESCRIPTION	ARTICLE	W x H x D (in mm)	UNIT	PET BOTTLES
EchoTorrent® 12mm DOT	ET012DOT079079A	1180 x 4000 x 40 (Ø 790)	1 Set	74

ECHOTORRENT® 24MM

Three hanging acoustic elements per set including suspension system
 Sound absorption: aw 1.00, Class A
Special dimensions and designs on request

DESCRIPTION	ARTICLE	W x H x D (in mm)	UNIT	PET BOTTLES
EchoTorrent® 24mm DOT	ET024DOT079079A	1180 x 4000 x 40 (Ø 790)	1 Set	104

ECHOTORRENT® 12MM
DOT

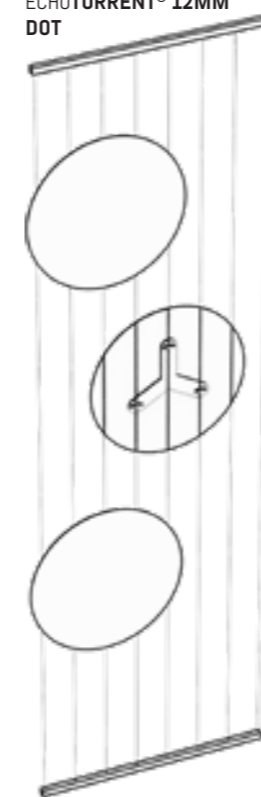

ECHOTORRENT® 24MM
DOT

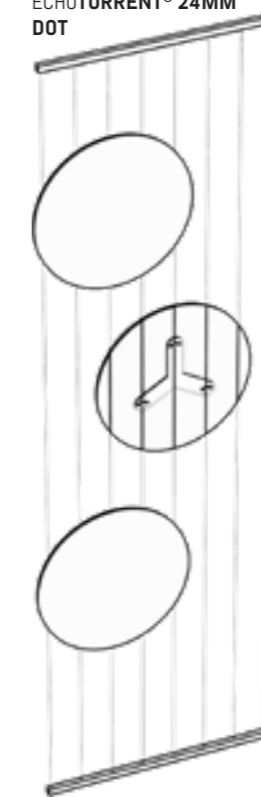

ECHOCOVE® ACOUSTIC ROOM DIVIDERS

With the EchoCove® family, ECHOJAZZ offers a wide range of acoustic products for various office situations: For the desk, as a modular room divider or even a mobile partition on wheels. No installation manual is required for the EchoCove® room dividers. The handy dividers can be combined with simple plug-in joints without tools. The elements can be pinned and the relatively high density of the material allows for frameless construction.

EchoCove® STAND offers a free-standing, frameless solution in the partition area. The acoustic partitions are available in four heights and two widths in the maximum dimensions of 180cm x 180cm together with a very high quality steel base. The elements cannot be linked together. Elements in the heights of 180cm and 142cm are mostly used as room dividers, the element with 122cm as a workstation partition between two workstations and the 59cm high element as a storage space attachment for acoustic separation in open-plan offices.





ECHOCOVE® 24MM ECO 79

Frameless movable acoustic wall elements with individual configuration excl. EchoCove® JOINER connectors (no tools required).
 Sound absorption: aw 1.00, Class A

Special dimensions and designs on request
 Please specify the Joiner type when ordering. (Page 68)

DESCRIPTION	ARTICLE	W x H x D (in mm)	UNIT	PET BOTTLES
EchoCove® 24mm ECO END 79 S	EC024END079122A	790 x 1220 x 24	1 Pce	68
EchoCove® 24mm ECO MID 79 S	EC024MID079122A	790 x 1220 x 24	1 Pce	68
EchoCove® 24mm ECO END 79 M	EC024END079142A	790 x 1420 x 24	1 Pce	79
EchoCove® 24mm ECO MID 79 M	EC024MID079142A	790 x 1420 x 24	1 Pce	79
EchoCove® 24mm ECO END 79 L	EC024END079180A	790 x 1800 x 24	1 Pce	101
EchoCove® 24mm ECO MID 79 L	EC024MID079180A	790 x 1800 x 24	1 Pce	101
EchoCove® 24mm ECO STEP END 79 M	EC024STE079142A	790 x 1420 x 24	1 Pce	79
EchoCove® 24mm ECO STEP MID 79 M	EC024STM079142A	790 x 1420 x 24	1 Pce	79
EchoCove® 24mm ECO STEP END 79 L	EC024STE079180A	790 x 1800 x 24	1 Pce	101
EchoCove® 24mm ECO STEP MID 79 L	EC024STM079180A	790 x 1800 x 24	1 Pce	101

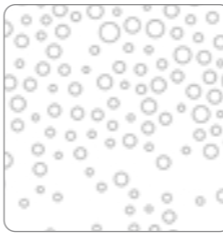

BUBBLES

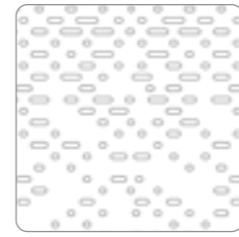

PUNCH

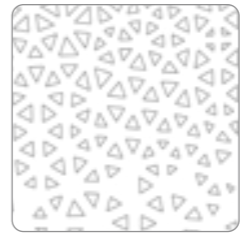

WEB

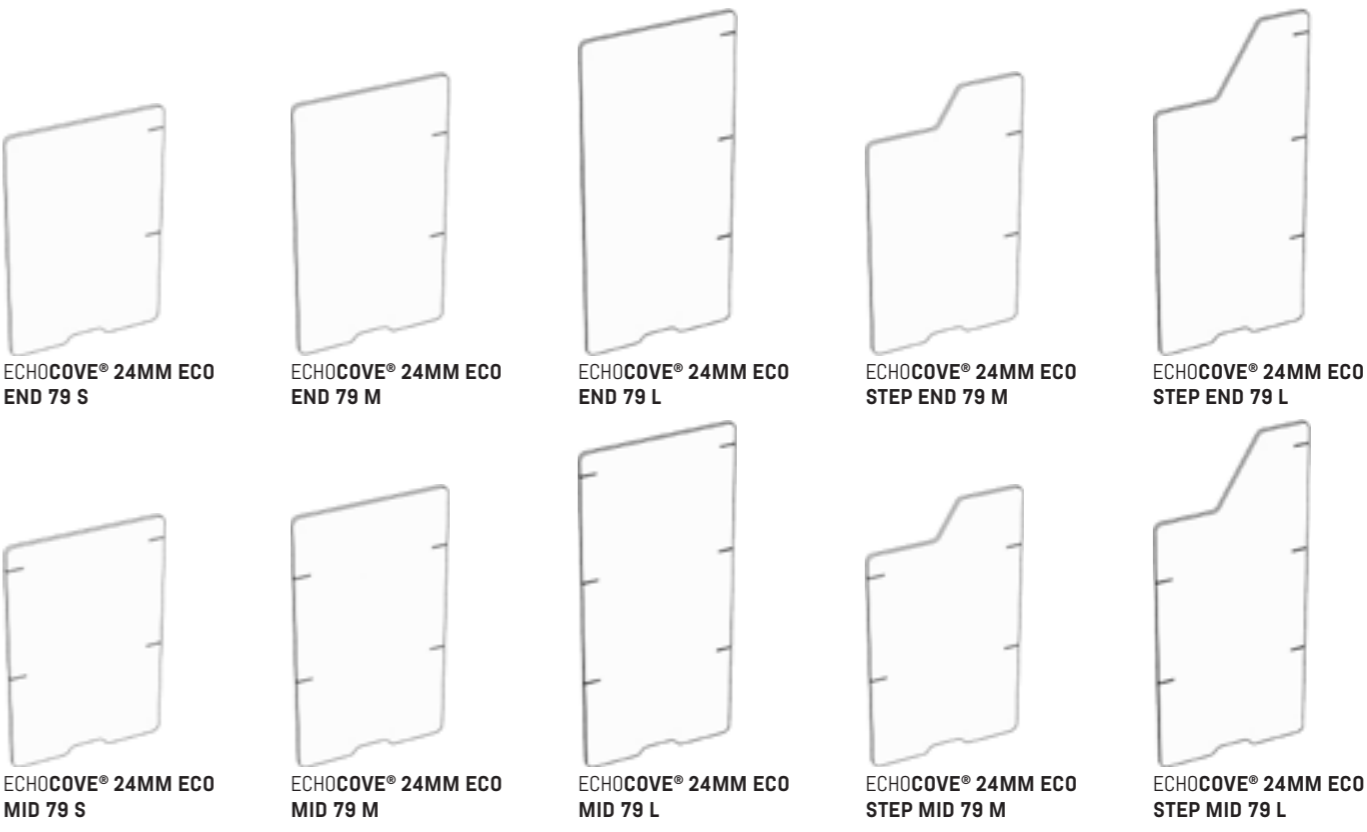

ECHOCOVE® 24MM ECO 159

Frameless movable acoustic wall elements with individual configuration excl. EchoCove® JOINER connectors (no tools required).

Sound absorption: aw 1.00, Class A

Special dimensions and designs on request

Please specify the Joiner type when ordering. (Page 68)

DESCRIPTION	ARTICLE	W x H x D (in mm)	UNIT	PET BOTTLES
EchoCove® 24mm ECO MID 159 S	EC024MID159122A	1585 x 1220 x 24	1 Pce	137
EchoCove® 24mm ECO MID 159 M	EC024MID159142A	1585 x 1420 x 24	1 Pce	159
EchoCove® 24mm ECO MID 159 L	EC024MID159180A	1585 x 1800 x 24	1 Pce	202

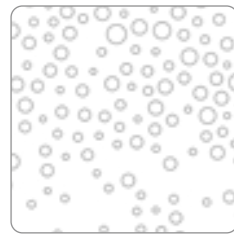

BUBBLES

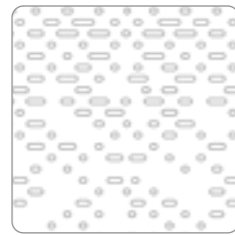

PUNCH

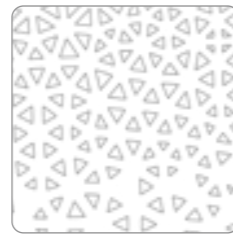

WEB

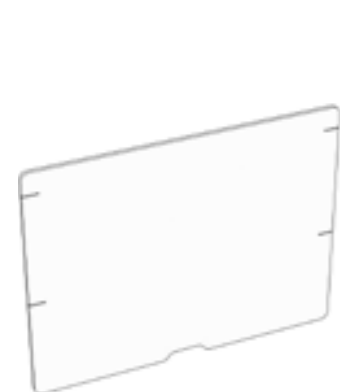

ECHOCOVE® 24MM ECO
MID 159 S

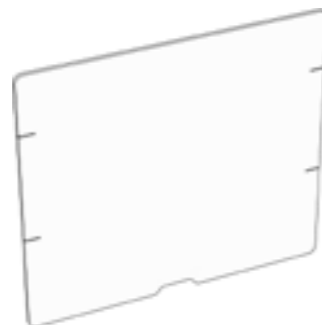

ECHOCOVE® 24MM ECO
MID 159 M

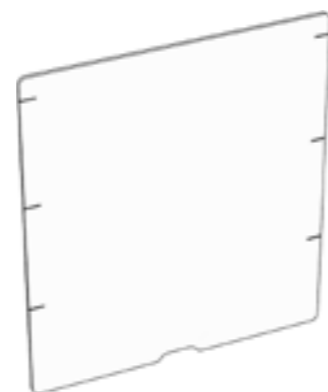

ECHOCOVE® 24MM ECO
MID 159 L

ECHOCOVE® 24MM ECO 180

Frameless movable acoustic wall elements with individual configuration excl. EchoCove® JOINER connectors (no tools required).

Sound absorption: aw 1.00, Class A

Special dimensions and designs on request

Please specify the Joiner type when ordering. (Page 68)

DESCRIPTION	ARTICLE	W x H x D (in mm)	UNIT	PET BOTTLES
EchoCove® 24mm ECO MID 180 S	EC024MID180122A	1800 x 1220 x 24	1 Pce	156
EchoCove® 24mm ECO MID 180 M	EC024MID180142A	1800 x 1420 x 24	1 Pce	181
EchoCove® 24mm ECO MID 180 L	EC024MID180180A	1800 x 1800 x 24	1 Pce	230

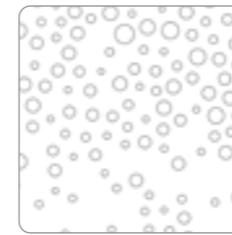

BUBBLES

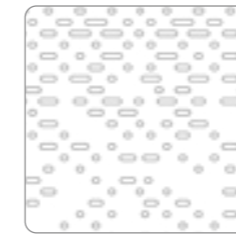

PUNCH

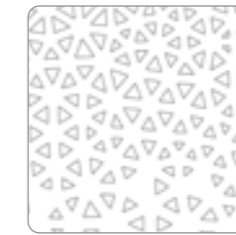

WEB

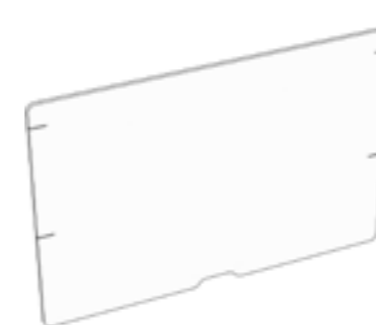

ECHOCOVE® 24MM ECO
MID 180 S

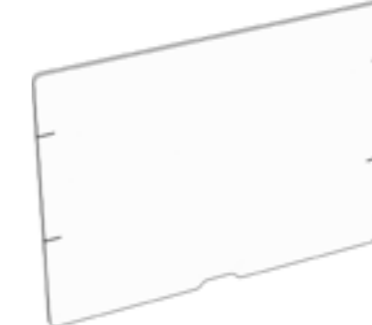

ECHOCOVE® 24MM ECO
MID 180 M

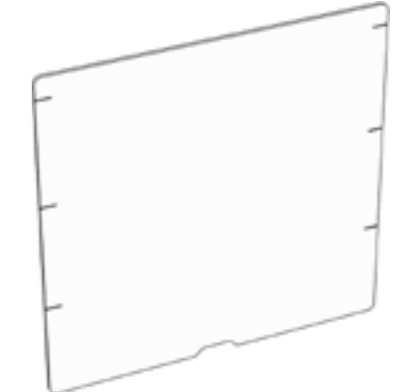

ECHOCOVE® 24MM ECO
MID 180 L



ECHOCOVE® 24MM PALING

Frameless acoustic folding wall incl. EchoCove® JOINER pivot-joint connector
Sound absorption: aw 1.00, Class A
Special dimensions and designs on request

DESCRIPTION	ARTICLE	W x H x D (in mm)	UNIT	PET BOTTLES
EchoCove® 24mm PALING	EC024PAL039180A	2125 x 1800 x 230	1 Set	297

ECHOCOVE® 24MM
PALING

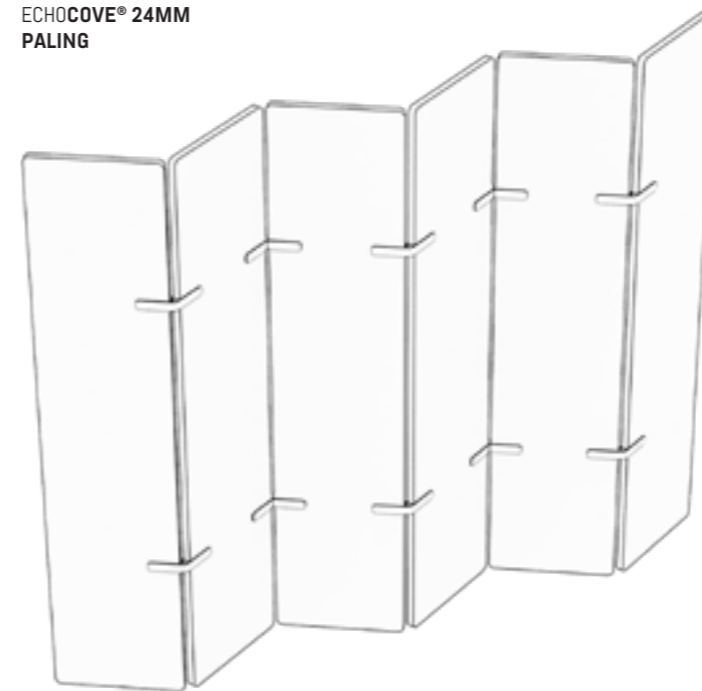



ECHOCOVE® 24MM STAND

Frameless acoustic partition wall for installation on the floor, team tables or storage furniture including high-quality adjustable foot, deep matt powder-coated (tool-free).

Sound absorption: aw 1.00, Class A

Colour of adjustable foot: Black RAL9005

For orders of 10 pieces or more, the foot is available in all RAL colours at an extra charge of 5%.

DESCRIPTION	ARTICLE	W x H x D (in mm)	UNIT	PET BOTTLES
EchoCove® 24mm STAND 160 S	ECO24STA160059A	1600 x 590 x 200	1 Set	67
EchoCove® 24mm STAND 160 M	ECO24STA160122A	1600 x 1220 x 400	1 Set	138
EchoCove® 24mm STAND 160 L	ECO24STA160142A	1600 x 1420 x 400	1 Set	161
EchoCove® 24mm STAND 160 XL	ECO24STA160180A	1600 x 1800 x 400	1 Set	204
EchoCove® 24mm STAND 180 S	ECO24STA180059A	1800 x 590 x 200	1 Set	75
EchoCove® 24mm STAND 180 M	ECO24STA180122A	1800 x 1220 x 400	1 Set	156
EchoCove® 24mm STAND 180 L	ECO24STA180142A	1800 x 1420 x 400	1 Set	181
EchoCove® 24mm STAND 180 XL	ECO24STA180180A	1800 x 1800 x 400	1 Set	230

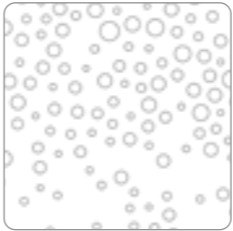

BUBBLES

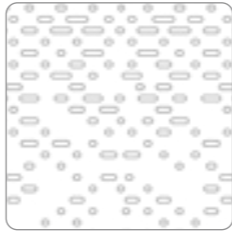

PUNCH

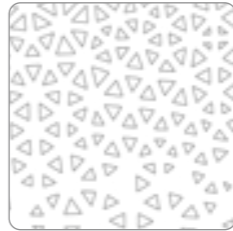

WEB

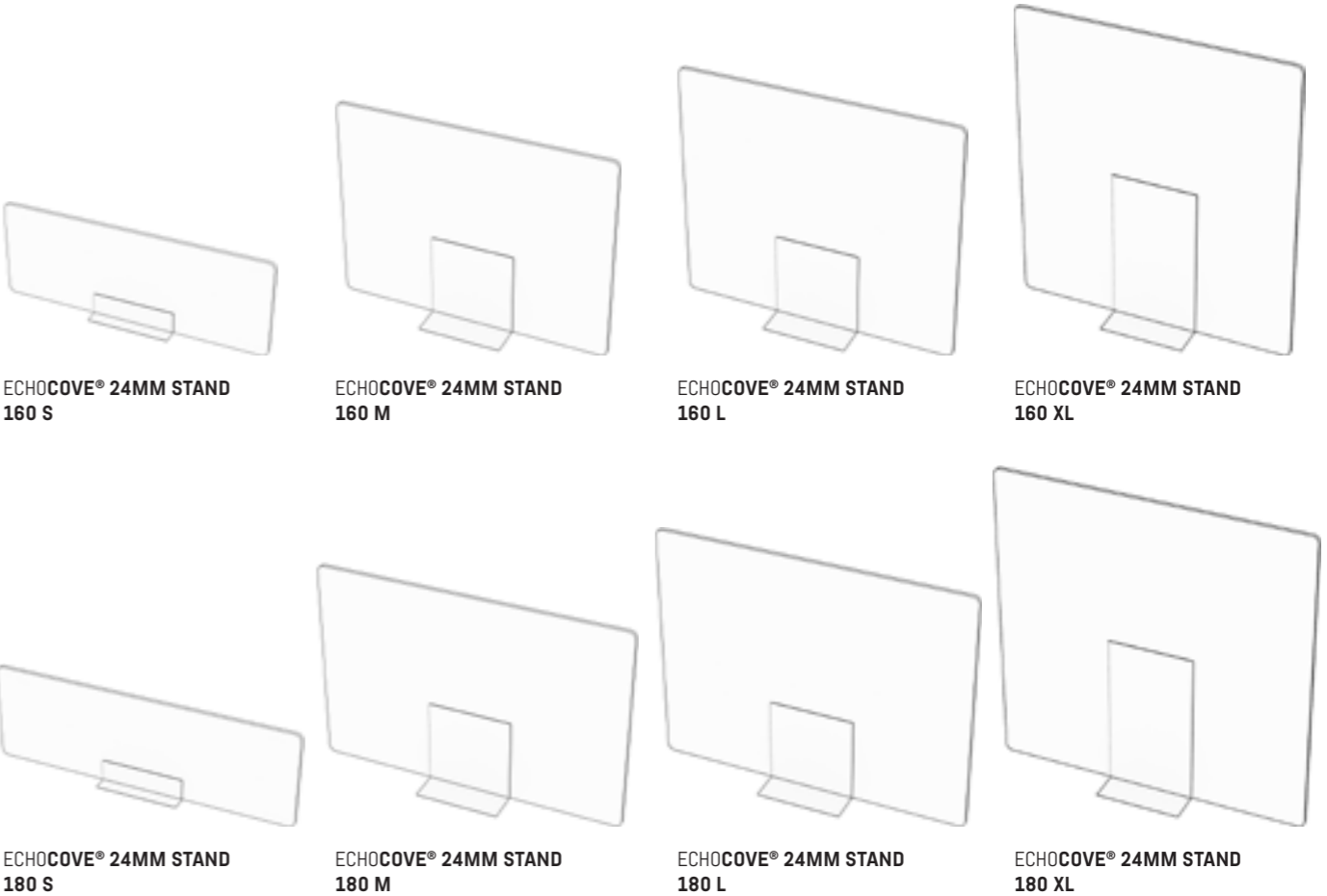

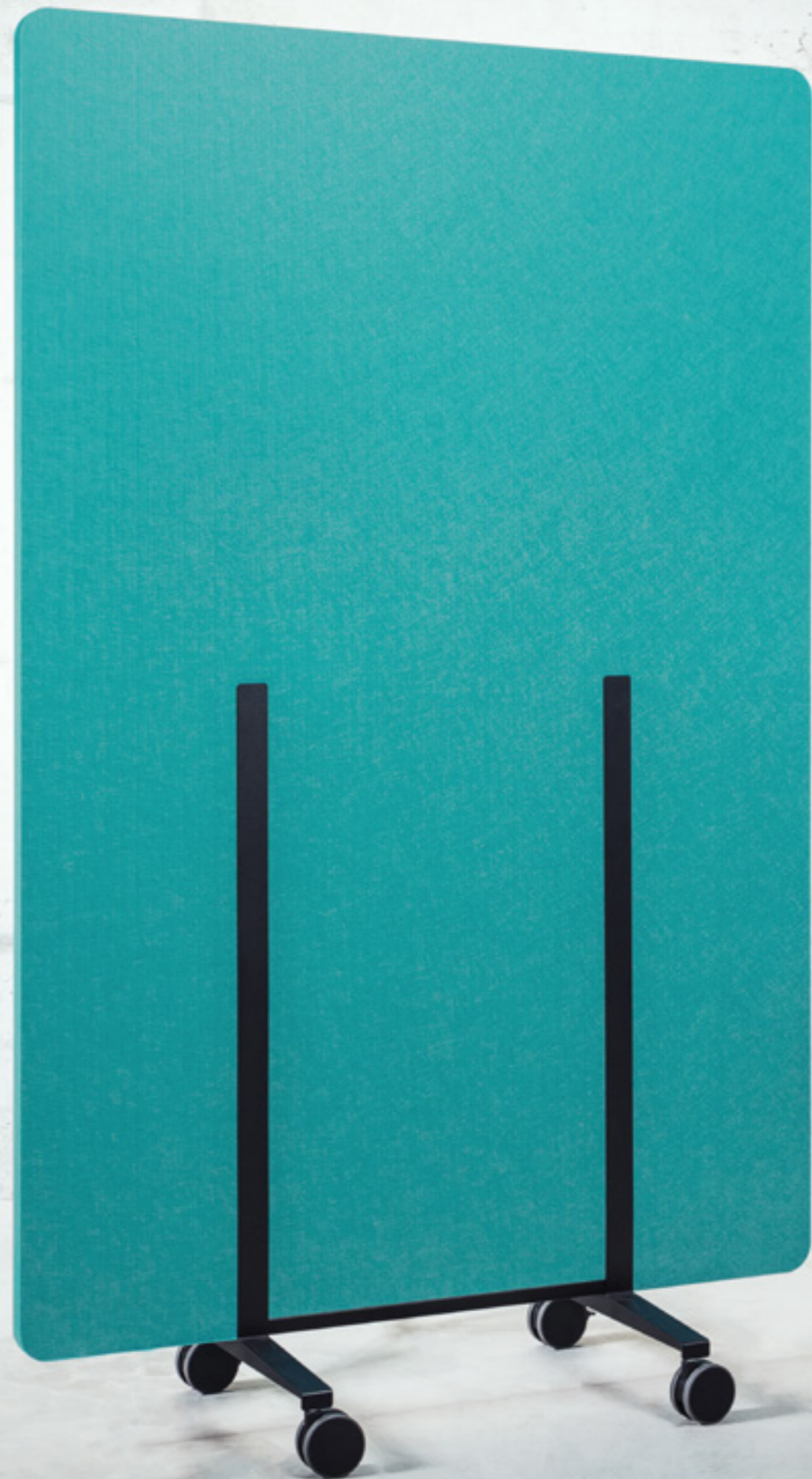

ECHOCOVE® 24MM MOVE

Frameless acoustic partition with high-quality base frame with wheels incl. stopper, deep matt powder-coated (tool-free)

Sound absorption: aw 1.00, Class A

Colour of adjustable foot: Black RAL9005

For orders of 10 pieces or more, the foot is available in all RAL colours at an extra charge of 5%.

DESCRIPTION	ARTICLE	W x H x D (in mm)	UNIT	PET BOTTLES
EchoCove® 24mm MOVE LOW S	EC024MOV118142A	1180 x 1420 x 430	1 Set	119
EchoCove® 24mm MOVE LOW M	EC024MOV160142A	1600 x 1420 x 430	1 Set	161
EchoCove® 24mm MOVE LOW L	EC024MOV180142A	1800 x 1420 x 430	1 Set	181
EchoCove® 24mm MOVE HIGH S	EC024MOV118180A	1180 x 1800 x 430	1 Set	150
EchoCove® 24mm MOVE HIGH M	EC024MOV160180A	1600 x 1800 x 430	1 Set	204
EchoCove® 24mm MOVE HIGH L	EC024MOV180180A	1800 x 1800 x 430	1 Set	230

ECHOCOVE® 24MM MOVE
LOW S



ECHOCOVE® 24MM MOVE
LOW M



ECHOCOVE® 24MM MOVE
LOW L

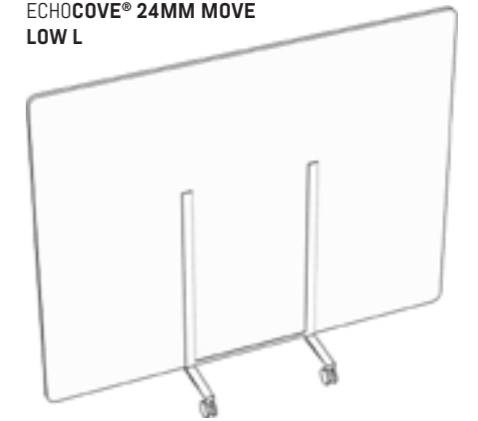

ECHOCOVE® 24MM MOVE
HIGH S



ECHOCOVE® 24MM MOVE
HIGH M

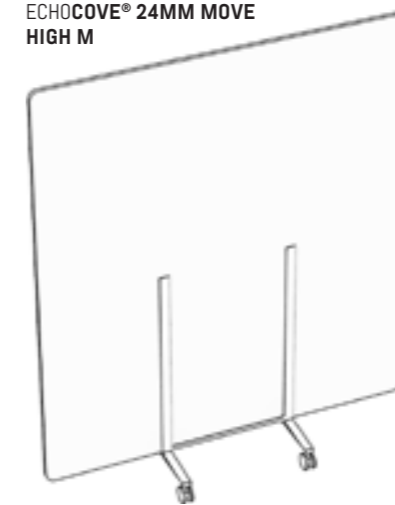

ECHOCOVE® 24MM MOVE
HIGH L

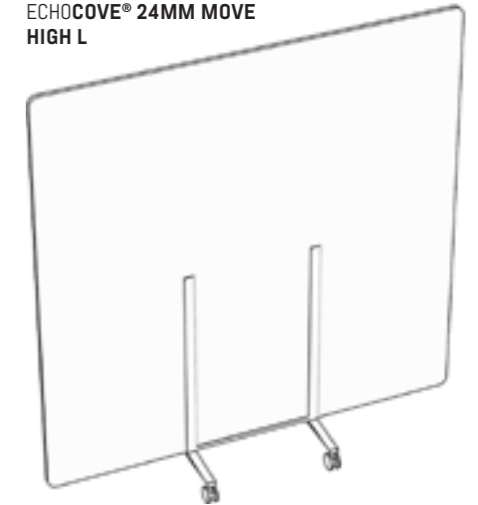



ECHOCOVE® 24MM DESK ONE

Frameless acoustic desktop wall incl. high-quality table adapter, deep matt powder-coated.

Sound absorption: aw 1.00, Class A

Please specify the Joiner type when ordering. (Page 69)

DESCRIPTION	ARTICLE	W x H x D (in mm)	UNIT	PET BOTTLES
EchoCove® 24mm DESK ONE 470 S	EC024DE1118047A	1180 x 470 x 24	1 Pce	39
EchoCove® 24mm DESK ONE 590 S	EC024DE1118059A	1180 x 590 x 24	1 Pce	49
EchoCove® 24mm DESK ONE 470 M	EC024DE1140047A	1400 x 470 x 24	1 Pce	47
EchoCove® 24mm DESK ONE 590 M	EC024DE1140059A	1400 x 590 x 24	1 Pce	59
EchoCove® 24mm DESK ONE 470 L	EC024DE1160047A	1600 x 470 x 24	1 Pce	53
EchoCove® 24mm DESK ONE 590 L	EC024DE1160059A	1600 x 590 x 24	1 Pce	67
EchoCove® 24mm DESK ONE 470 XL	EC024DE1180047A	1800 x 470 x 24	1 Pce	60
EchoCove® 24mm DESK ONE 590 XL	EC024DE1180059A	1800 x 590 x 24	1 Pce	75

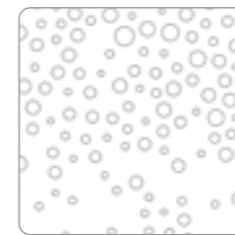

BUBBLES

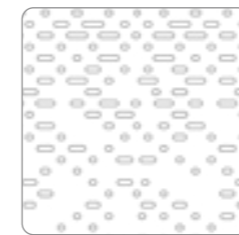

PUNCH



WEB

ECHOCOVE® 24MM
DESK ONE 470 S



ECHOCOVE® 24MM
DESK ONE 470 M



ECHOCOVE® 24MM
DESK ONE 470 L



ECHOCOVE® 24MM
DESK ONE 470 XL



ECHOCOVE® 24MM
DESK ONE 590 S



ECHOCOVE® 24MM
DESK ONE 590 M



ECHOCOVE® 24MM
DESK ONE 590 L



ECHOCOVE® 24MM
DESK ONE 590 XL





ECHOCAVE® 24MM DESK TWO

Frameless acoustic desktop wall incl. high-quality table adapter, deep matt powder-coated.
 Sound absorption: aW 1.00, Class A
 Please specify the Joiner type when ordering. (Page 69)

DESCRIPTION	ARTICLE	W x H x D (in mm)	UNIT	PET BOTTLES
EchoCave® 24mm DESK TWO 470 XS	ECO24DE2079077A	790 x 770 x 24 (470 ü. Tischplatte)	1 Pce	43
EchoCave® 24mm DESK TWO 590 XS	ECO24DE2079089A	790 x 890 x 24 (590 ü. Tischplatte)	1 Pce	50
EchoCave® 24mm DESK TWO 470 S	ECO24DE2118077A	1180 x 770 x 24 (470 ü. Tischplatte)	1 Pce	64
EchoCave® 24mm DESK TWO 590 S	ECO24DE2118089A	1180 x 890 x 24 (590 ü. Tischplatte)	1 Pce	74
EchoCave® 24mm DESK TWO 470 M	ECO24DE2140077A	1400 x 770 x 24 (470 ü. Tischplatte)	1 Pce	76
EchoCave® 24mm DESK TWO 590 M	ECO24DE2140089A	1400 x 890 x 24 (590 ü. Tischplatte)	1 Pce	88
EchoCave® 24mm DESK TWO 470 L	ECO24DE2160077A	1600 x 770 x 24 (470 ü. Tischplatte)	1 Pce	87
EchoCave® 24mm DESK TWO 590 L	ECO24DE2160089A	1600 x 890 x 24 (590 ü. Tischplatte)	1 Pce	101
EchoCave® 24mm DESK TWO 470 XL	ECO24DE2180077A	1800 x 770 x 24 (470 ü. Tischplatte)	1 Pce	98
EchoCave® 24mm DESK TWO 590 XL	ECO24DE2180089A	1800 x 890 x 24 (590 ü. Tischplatte)	1 Pce	113

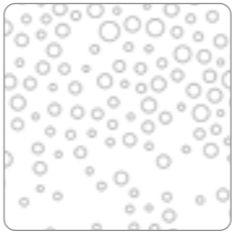

BUBBLES

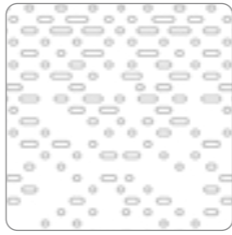

PUNCH

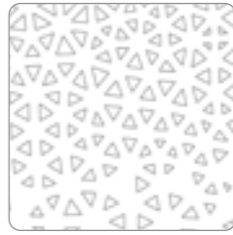

WEB

ECHOCAVE® 24MM
DESK TWO 470 XS



ECHOCAVE® 24MM
DESK TWO 470 S



ECHOCAVE® 24MM
DESK TWO 590 XS



ECHOCAVE® 24MM
DESK TWO 590 S



ECHOCAVE® 24MM
DESK TWO 470 M



ECHOCAVE® 24MM
DESK TWO 470 L

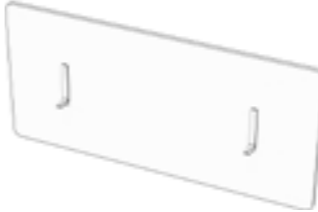

ECHOCAVE® 24MM
DESK TWO 590 M

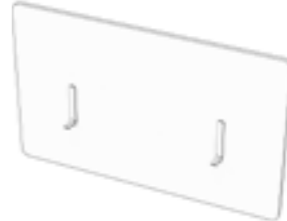

ECHOCAVE® 24MM
DESK TWO 590 L

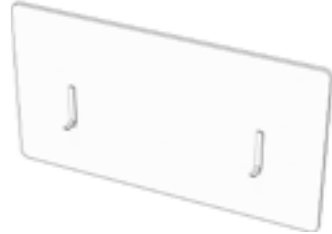

ECHOCAVE® 24MM
DESK TWO 470 XL



ECHOCAVE® 24MM
DESK TWO 590 XL

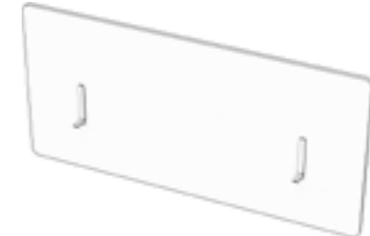

ECHOCOVE® JOINER

Plastic plug connector for tool-free installation of EchoCove® 24mm ECO partitions.

All joiners (except EchoCove® JOINER PIVOT) are also available in powder-coated metal (beige and grey).

DESCRIPTION	ARTICLE	W x H x D (in mm)	UNIT	PET BOTTLES
EchoCove® JOINER 120	EJ000120100000A	Joiner for EchoCove® ECO	1 pair	-
EchoCove® JOINER 90	EJ000090100000A	Joiner for EchoCove® ECO	1 pair	-
EchoCove® JOINER PIVOT	EJ000PIV100000A	Joiner for EchoCove® ECO	1 pair	-
EchoCove® JOINER STRAIGHT	EJ000STR200000A	Joiner for EchoCove® ECO	1 pair	-
EchoCove® JOINER T	EJ000TJO100000A	Joiner for EchoCove® ECO	1 pair	-
EchoCove® JOINER X	EJ000XJO100000A	Joiner for EchoCove® ECO	1 pair	-

ECHOCOVE® JOINER
120



ECHOCOVE® JOINER
90



ECHOCOVE® JOINER
PIVOT



ECHOCOVE® JOINER
STRAIGHT



ECHOCOVE® JOINER
T

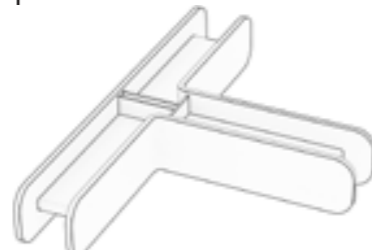

ECHOCOVE® JOINER
X

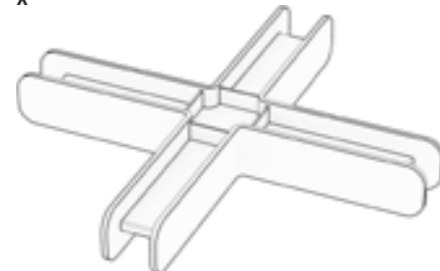

ECHOCOVE® DESK ADAPTER

Powder-coated metal adapter for mounting EchoCove® 24mm DESK ONE and DESK TWO

Adapter colour: Black RAL9005

From an order quantity of 20 sets, the desk adapters are available in all RAL colours for an additional 5%.

DESCRIPTION	ARTICLE	W x H x D (in mm)	UNIT	PET BOTTLES
EchoCove® ADAPTER A	EAD00ECA000000A	For direct mounting under table top	1 Pair	-
EchoCove® ADAPTER B	EAD30ECB000000A	For table tops up to 30mm thickness	1 Pair	-
EchoCove® ADAPTER C	EAD50ECC000000A	For table tops from 46 to 75mm thickness	1 Pair	-

ECHOCOVE® ADAPTER
A

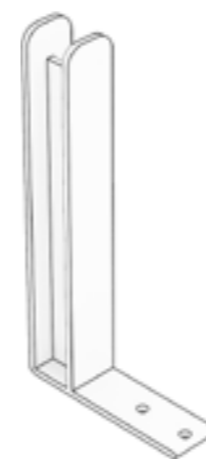

ECHOCOVE® ADAPTER
B

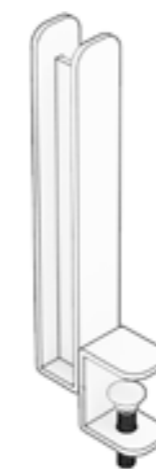

ECHOCOVE® ADAPTER
C



DO YOU ALREADY KNOW ABOUT ECHOCOUSTIC®?

The EchoCoustic® is a high quality sound absorber which can be mounted on walls and ceilings without any spacing, achieving a sensational sound absorption of 85%. Compared to the EchoBoard®, the EchoCoustic® is 3-layered with a material thickness of 25mm. EchoCoustic is also made of 100% PET, of which at least 50% is recycled. The surface impresses with its beautiful and smooth high-tech felt and is available in 34 colours. The middle layer gives the EchoCoustic® its stiffness and makes the product pinable. The base is responsible for the excellent acoustic values, especially in the low frequency range.

The installation of the EchoCoustic® is extremely easy, which is supported by the optional frame. Since the EchoCoustic® is mounted directly on the wall or ceiling, the loss of space is very small and the acoustic performance is excellent.

For more information please contact us directly via email. (info@echojazz.com)



DOWNLOADS

PRODUCT SHEET

I AM LOOKING FOR...

BROCHURE

CAD

CERTIFICATES

COLORS

MAINTENANCE

PICTURES

PRODUCT SHEETS

PRODUCTS

Type to start searching for specific file...

SEARCH

WWW.ECHOJAZZ.COM

ECHOJAZZ offers various additional services for its customers via the Internet. On our website you will find further information about our products, services, projects and partners. For example, do you need CAD data for one of our products? In the download area the most requested data are already available for everyone. If you want a quote for one of our standard products, you can request it quickly and easily via the integrated online product configurator. Do you simply want to be kept up to date with general information? Just follow us via one of our social media channels or subscribe to the ECHOJAZZ newsletter!

Downloads



Colors



Certificates

ECHOJAZZ

INSPIRED BY ACOUSTICS AND SUSTAINABILITY

100% PET ACOUSTIC ABSORBERS

VERSION: EN 27.02.2020
VALID UNTIL: 01.07.2020